

System **O**peration

System Operation: Innovation Landscape

- Future role of distribution system operators
- Co-operation between transmission and distribution system operators
- Advanced forecasting of variable renewable power generation
- Innovative operation of pumped hydropower storage
- Virtual power lines
- Dynamic line rating

FUTURE ROLE OF DISTRIBUTION SYSTEM OPERATORS

INNOVATION LANDSCAPE BRIEF

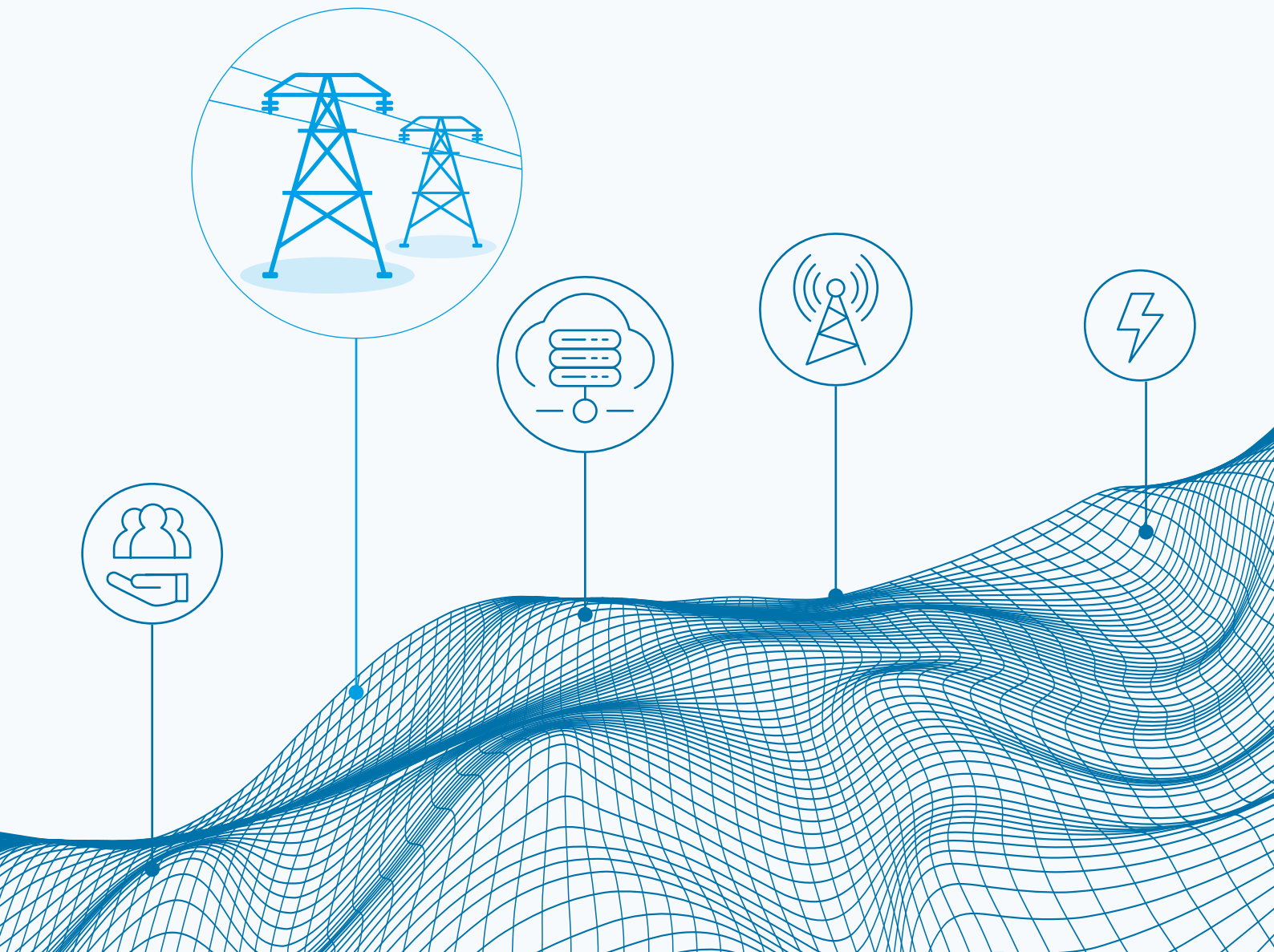

© IRENA 2019

Unless otherwise stated, material in this publication may be freely used, shared, copied, reproduced, printed and/or stored, provided that appropriate acknowledgement is given of IRENA as the source and copyright holder. Material in this publication that is attributed to third parties may be subject to separate terms of use and restrictions, and appropriate permissions from these third parties may need to be secured before any use of such material.

ISBN 978-92-9260-115-7

Citation: IRENA (2019), *Innovation landscape brief: Future role of distribution system operators*, International Renewable Energy Agency, Abu Dhabi.

About IRENA

The International Renewable Energy Agency (IRENA) is an intergovernmental organisation that supports countries in their transition to a sustainable energy future, and serves as the principal platform for international co-operation, a centre of excellence, and a repository of policy, technology, resource and financial knowledge on renewable energy. IRENA promotes the widespread adoption and sustainable use of all forms of renewable energy, including bioenergy, geothermal, hydropower, ocean, solar and wind energy in the pursuit of sustainable development, energy access, energy security and low-carbon economic growth and prosperity. www.irena.org

Acknowledgements

This report was prepared by the Innovation team at IRENA's Innovation and Technology Centre (IITC) and was authored by Arina Anisie, Francisco Boshell and Elena Ocenic with additional contributions and support by Harsh Kanani, Shikhin Mehrotra (KPMG India).

Valuable external review was provided by Jörn Richstein (German Institute for Economic Research (DIW Berlin)), Pedro Godinho Matos (EDP), Helena Gerard (VITO) and Gianluigi Migliavacca (RSE), along with Carlos Fernández and Harold Anuta (IRENA).

Disclaimer

This publication and the material herein are provided "as is". All reasonable precautions have been taken by IRENA to verify the reliability of the material in this publication. However, neither IRENA nor any of its officials, agents, data or other third-party content providers provides a warranty of any kind, either expressed or implied, and they accept no responsibility or liability for any consequence of use of the publication or material herein.

The information contained herein does not necessarily represent the views of all Members of IRENA. The mention of specific companies or certain projects or products does not imply that they are endorsed or recommended by IRENA in preference to others of a similar nature that are not mentioned. The designations employed and the presentation of material herein do not imply the expression of any opinion on the part of IRENA concerning the legal status of any region, country, territory, city or area or of its authorities, or concerning the delimitation of frontiers or boundaries.

Photographs are from Shutterstock unless otherwise indicated.

This document does not represent the official position of IRENA on any particular topic. Rather, it is intended as a contribution to technical discussions on the promotion of renewable energy.

1 GROWING RESPONSIBILITIES FOR DSOs

Traditional power system structure



Power system structure with DER deployment

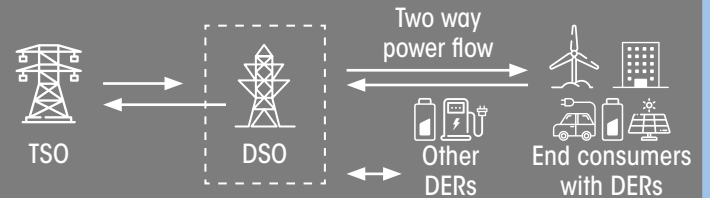

Conventional roles of DSO

- 🔗 Connection and disconnection of DERs
- 📄 Planning, maintenance and management of networks
- 🏠 Management of supply outages
- 💰 Energy billing (only if vertically integrated)

Emerging additional roles of DSO

- 🏭 Peak load management through DERs
- 🌐 Network congestion management
- ⚡ Provide reactive power support to TSOs
- ⚡ Procure voltage support
- ✓ Technical validation for power market

3 SNAPSHOT

- 📊 UK Power Networks **reduced peak demand by 60 %** by aggregating DERs through a virtual power plant.
- 📄 The European Union's draft Electricity Regulation requires DSOs to facilitate the integration of distributed energy resources
- 🏆 The **US** and **EU** countries are front-runners in expanding DSO responsibilities

2 KEY ENABLING FACTORS

- 🕒 Deploying smart meters
- 📡 Real-time monitoring
- ⚖️ Leveling the playing field for aggregators, prosumers and other flexibility providers
- 📍 Establishing local market places for flexibility

WHAT ARE DSO's NEW OPPORTUNITIES?

With DERs available, a DSO can boost **grid flexibility** and **reduce** network investment needs

FUTURE ROLE OF DSOs

With more distributed energy resources (DERs), the role of distribution system operators (DSOs) expands towards optimisation of local generation and consumption.

ABOUT THIS BRIEF

This brief forms part of the IRENA project “Innovation landscape for a renewable-powered future”, which maps the relevant innovations, identifies the synergies and formulates solutions for integrating high shares of variable renewable energy (VRE) into power systems.

The synthesis report, *Innovation landscape for a renewable-powered future: Solutions to integrate variable renewables* (IRENA 2019), illustrates the need for synergies between different innovations

to create actual solutions. Solutions to drive the uptake of solar and wind power span four broad dimensions of innovation: enabling technologies, business models, market design and system operation.

Along with the synthesis report, the project includes a series of briefs, each covering one of 30 key innovations identified across those four dimensions. The 30 innovations are listed in the figure below.

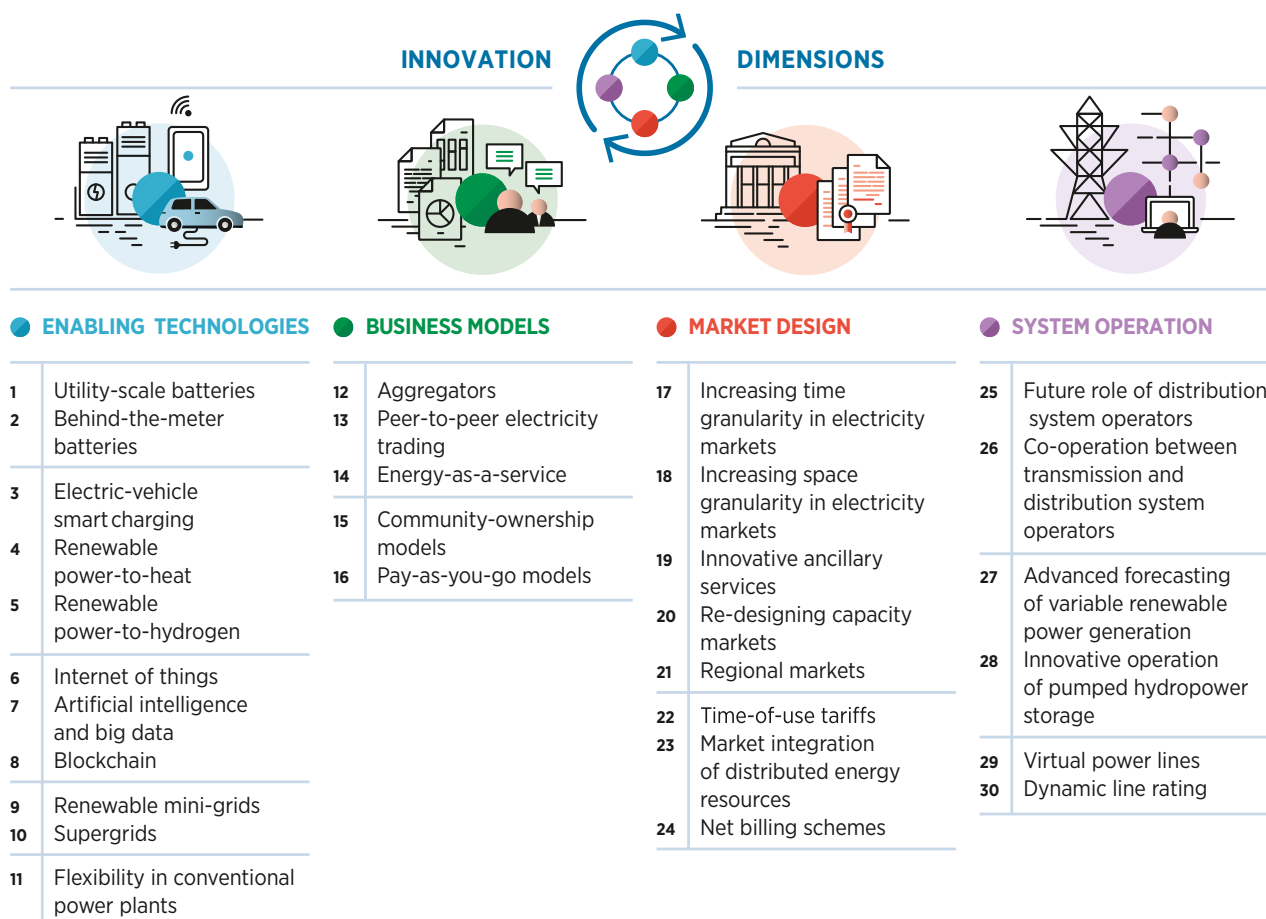

This brief examines a key area of innovation in system operation, as distribution system operators (DSOs) take on greater responsibilities. The future

role of DSOs will reflect the need to utilise the increased volume of distributed energy resources (DERs) in electrical distribution networks.

Distributed energy resources (DERs) are small or medium-sized resources, directly connected to the distribution network (EC, 2015). DERs include distributed generation, energy storage (small scale batteries) and controllable loads, such as electric vehicles (EVs), heat pumps or demand response.

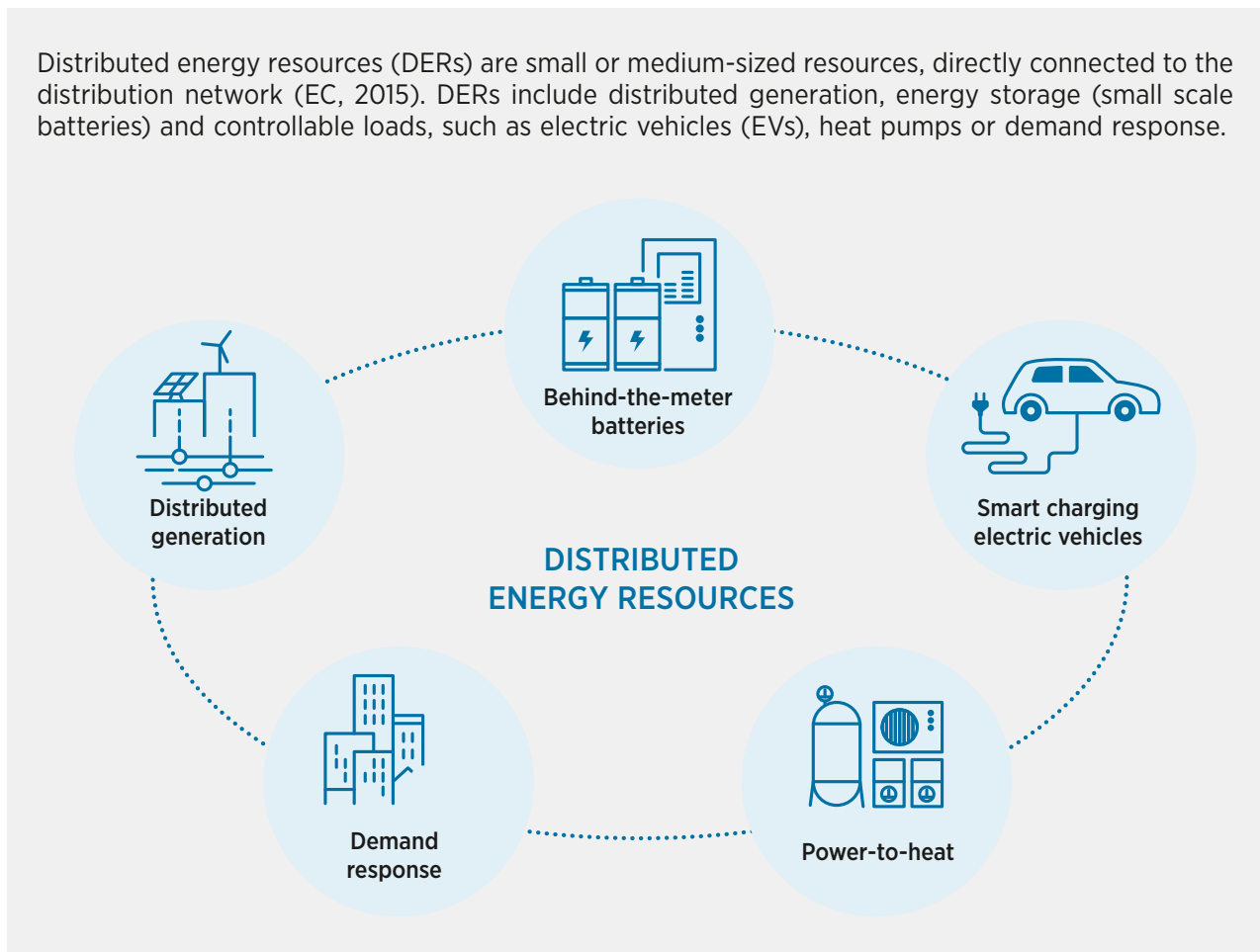

Optimising both the consumption and the generation of electricity that is locally produced provides a great advantage for the distribution system, decreasing the need for other costly flexibility measures. In addition, the rapid growth of grid-connected distributed energy resources can be supported and enabled by harnessing the benefits that they can provide to the system. This brief focuses on expanding the role of distribution system operators to include the market-based procurement and operation of distributed energy resources, providing flexibility services.

The new role of DSO would include, depending on the regulatory framework in place:

- DSOs as neutral market facilitators (e.g., by avoiding ownership of electricity storage and EV charging infrastructure);
- Market-based procurement of grid services from distributed energy resources; and

- Benefiting from distributed energy resources by optimising the use of existing distribution grids and deferring new investments, either through direct control (operation) of distributed energy resources or through market-based price signals to other actors in the electricity system, such as aggregators.

The brief is structured as follows:

- I [Description](#)
- II [Contribution to power sector transformation](#)
- III [Key factors to enable deployment](#)
- IV [Current status and examples of ongoing initiatives](#)
- V [Implementation requirements: Checklist](#)

I. DESCRIPTION

Traditionally, electric power systems have been centralised structures organised into generation, transmission and distribution, placing customers at the end of the supply chain. This is a unidirectional structure where electricity generated by large power plants is transported via transmission and distribution networks to be delivered to customers. However, recent decades have witnessed the emergence of distributed energy resources (DERs) such as rooftop solar PV installations, micro wind turbines, battery energy storage systems, plug-in electric vehicles and smart home appliances that are becoming active participants in the electricity system.

The increasing penetration of decentralised energy resources and the emergence of new market players – such as prosumers, aggregators and active consumers – will usher in a new era. To take advantage of these new opportunities and to keep pace with both the transformation of the power sector and changing customer needs, distribution system operators will need to adjust their current role. Changing the regulatory framework for the DSOs – introducing new incentives to adapt the operation of distribution networks to the new paradigm of DERs – is key for the success of the energy transition.

Figure 1 depicts the difference between the conventional power system and the emerging scenario due to the deployment of DERs.

Figure 1 Conventional scenario versus emerging scenario in the power system due to the emergence of distributed energy resources

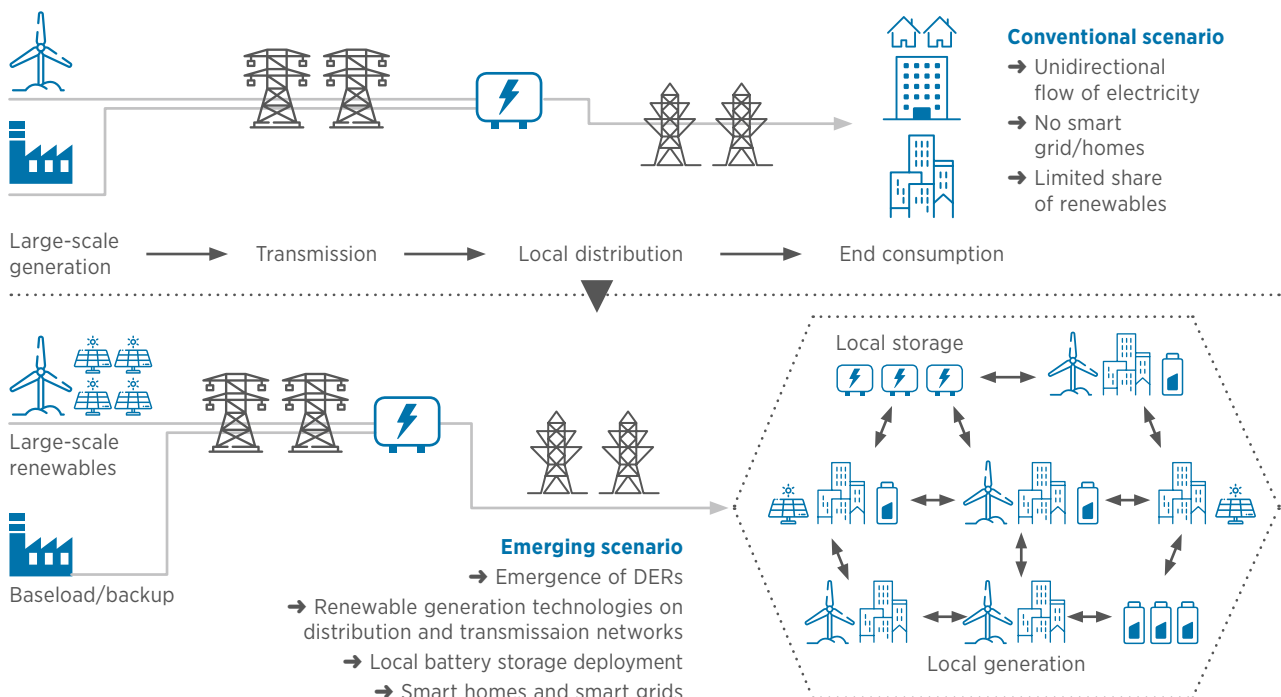

With the emergence of distributed energy resources – such as distributed generation, demand-side response and storage – the role of DSOs will expand. As such, DSOs could have access to the distributed flexibilities connected to their grid for the benefit of both the distribution grid and consumers. In their new role, DSOs could operate the distributed energy resources, if the regulatory framework allows it. If not, DSOs could at least act as neutral market facilitators and provide high-resolution price signals to the market players that own such flexibility assets. Having access to distributed flexibilities would have a two-fold objective of optimising the use of the distribution networks and minimising the need for future grid investments.

The increasing penetration of DERs could lead to a less predictable and reverse flow of power in the system, which can affect the traditional planning and operation of distribution and transmission networks. Further, increased deployment of DERs is expected to cause congestion in the distribution grid, which must be actively managed. This raises the need for a change in the role of the DSOs that have conventionally planned, maintained and managed networks and supply outages.

To effectively benefit from the available flexibility of DERs connected to the distribution network, DSOs could deepen their role as active system operators, in addition to their role as network operators. Distribution system operators could procure flexibility services from their network users, such as voltage support and congestion management to defer network investments.

In addition, DSOs might provide reactive power support to transmission system operators (TSO). For example, DSOs could, in co-operation with the TSO, define the standardised market products for the services to be procured via these flexibilities, including the definition of technical modalities for participating in dedicated markets. DSOs could use such flexibility services, among others, for the management of local congestion and non-frequency ancillary services (e.g., voltage control), while TSOs would be responsible solely for frequency ancillary services.

The new role of DSOs vis-à-vis their conventional role is depicted in Figure 2.

Figure 2 The new role of distribution system operators

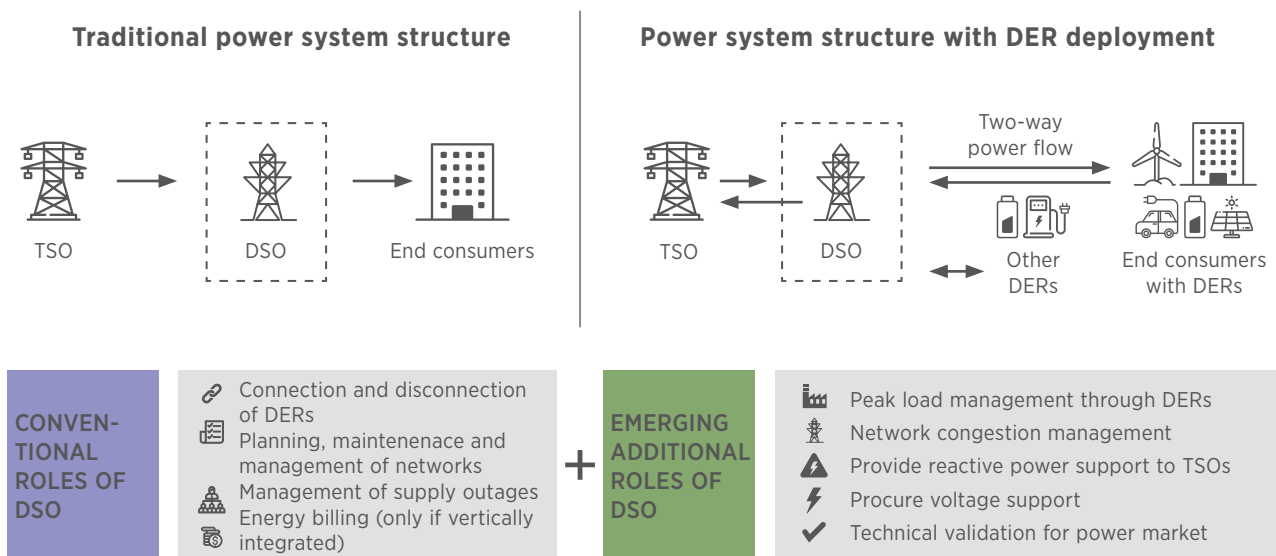

Some of the regulatory mechanisms that could foster this new role include:

- **Non-firm connection agreements for end-consumers** – These are connection agreements wherein the consumer agrees to have constrained power supply during peak hours, and the network fee is reduced as compared to firm connection agreements.
- **Bilateral flexibility contracts** – This refers to contractual agreements between DSOs and DER's owners to provide local system services – such as voltage control, peak shaving and congestion management – to the DSO.
- **Local markets** – This refers to local flexibility markets for distribution system services in which DERs could participate to support the distribution grid. The output of these markets could be technically validated by the DSO, in co-operation with the TSO.

A relevant initiative in this regard exists within the new regulatory framework of the European Commission's Clean Energy for All Europeans legislative package in November 2016. The revised Electricity Directive, which will enter into force in 2019 and is applicable to all European Union (EU) Member States following negotiation of the proposal, sets the regulatory framework in which distribution system operators can procure

flexible services from network users (EC, 2016; EC, 2018). For example, this could be done via bilateral contracts between renewable energy owners and DSOs or via economic incentives set by DSOs (prices with some locational / temporal differentiation).

This new regulatory framework foresees that DSOs can own (and operate directly) flexible DERs only under specific circumstances. These include, for example, instances where no other parties have expressed an interest, or where the storage facility is necessary for fulfilling the DSO's obligations, and subject to the approval of the national regulator. The primary role of DSOs is to act as a neutral market facilitator for flexibility services.

In the United Kingdom (UK), variable network access for distributed generation exists in the form of non-firm connection agreements. Such agreements allow the distributor to temporarily curtail the power injection or withdrawal of an end-user for security reasons. A trade-off exists between reducing the value of renewable energy due to curtailment and the benefits reaped from swifter integration of renewables-based distributed generation. Thus, solutions should be promoted to keep the amount of curtailed renewable energy low – preventing costly grid reinforcement, increasing network hosting capacity and allowing for more rapid connection and access for distributed generation.



II. CONTRIBUTION TO POWER SECTOR TRANSFORMATION

The new role of DSOs will have a significant impact on the way the power system is operated today. Figure 3 depicts some key benefits that can be reaped from this change in role.

Figure 3 Key advantages of the new role of distribution system operators

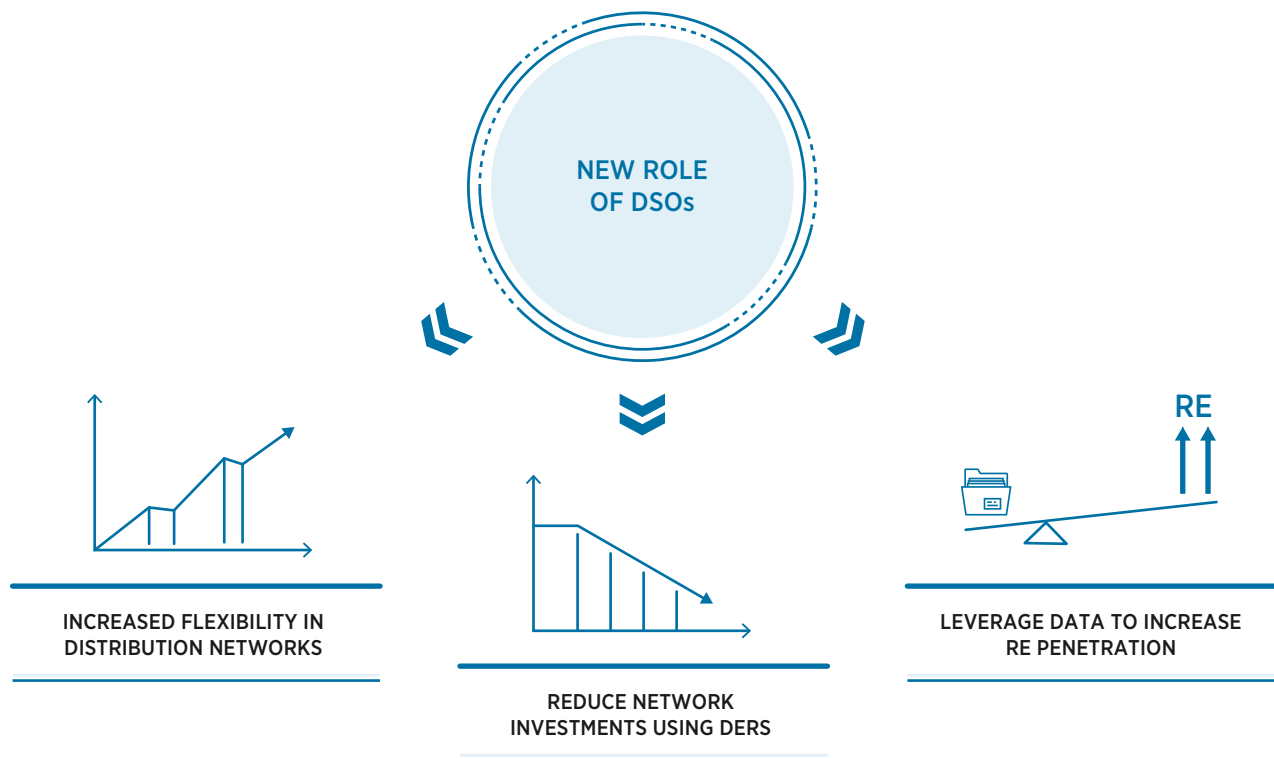

Increasing flexibility in distribution networks

Taking advantage of the increased penetration of DERs, DSOs could procure flexibility services – such as voltage support, congestion management, peak shaving, etc. – from the assets that are already connected to their distribution network. Using such services would further contribute to the integration of renewables in the distribution grid and especially the integration of variable renewable energy sources.

One way to achieve this is through the introduction of locational price signals in the distribution grids, or the establishment of local markets. Bilateral long-term contracts are a short-term solution and are easier to implement when the number of market participants is limited. The extra revenue stream for providing these flexibility services would incentivise the owners of the distributed energy resources to further deploy these resources, which in turn increases the flexibility in the distribution network.

Using distributed energy resources to avoid or reduce network investments

DSOs have conventionally invested in network reinforcement to reduce network congestion that could occur during peak demand intervals. Thus, the rules under which DSOs plan and size their grids – for example, in response to a worst-case scenario – could be modified to allow DSOs some freedom to decide whether a) to reinforce the grid, b) to offer non-firm access to their users (consumers, as well as generators) or c) to use flexibility services provided by DERs. By optimally managing DERs across the distribution network and mandating them to comply with certain communication requirements and dispatch signals, DSOs could avoid congestion and defer costly network investments.

Similarly, meeting peak load demand through locally stored or generated energy instead of transporting generation from a distant source may decrease grid congestion and defer network investments. For example, battery storage systems deployed by end-consumers could store excess energy produced from renewable sources such as solar PV or be charged using grid electricity when it is relatively cheap. Batteries can then be discharged during peak time intervals to fulfil demand. Using DERs, and in particular batteries, to avoid investments in the grid is also known as virtual power lines.

For example, UK Power Networks, a DSO operating in the UK, recently announced its plan to create London's first virtual power plant (VPP), comprising solar panels and a fleet of batteries across 40 homes in London. A trial of this concept was conducted in February 2018 wherein a fleet of 45 batteries was used to fulfil peak demand. The project is expected to provide an alternative to the traditional approach of increasing network capacity to meet peak demand (Hill, 2018).

Leveraging data to increase renewable energy penetration

DSOs can serve as the central hub for managing consumer data related to electricity consumption, production, billing and location, as well as the type of DERs. DSOs can collect and store these data according to the prescribed regulatory standards while protecting consumer rights, including privacy. For instance, the EU's Clean Energy for All Europeans package contains, among others, common rules for data management, including a common European data format requirement, where DSOs would have to ensure non-discriminatory access to data from smart metering systems (Hancher and Winters, 2017).

Using these data, DSOs can better forecast demand, leading to better planning and system operation. Such data also can enable greater deployment of renewable energy by helping consumers understand their consumption and / or production patterns and make efficient decisions about their distribution network use. DSOs could share such data neutrally and transparently with consumers as well as third parties, according to the prescribed data-sharing regulations, to enable better decision making.

In particular, third parties such as Energy-as-a-Service (EaaS) providers could utilise such data to provide optimal energy management services to end-consumers, thereby helping them in providing more flexibility to the system as well as increasing their energy efficiency. Gathering and sharing such data would not only help DSOs in operating the grid better, but also allow third parties to explore new business models for end-consumers, while helping end-consumers play an active role in the energy system, such as through demand-side response schemes.

For example, the regulatory proceedings under New York State's Reforming the Energy Vision encourage sharing information and knowledge about the utility grid. The six utilities¹ participating in this programme recently filed a plan in which they will provide data on the distribution grid in three stages. The first stage involves upgrading the grid with smart meters, sensors and other such communication and data collection hardware.

In the second stage, the data collected by these devices will enable a marketplace between utilities and DERs. In the third stage, this will be extended to the rest of the market and will enable third-party service providers such as rooftop solar companies, Energy-as-a-service providers, etc. to leverage these data to provide better services (Trabish, 2017).

Potential impact on power sector transformation

- In the UK innovations by DSOs – including in creating smarter networks, improving transmission-distribution processes related to connections of distributed generation, planning and shared services, assessing the gaps in customer experience and considering the changing requirements of transmission and distribution systems – will enable **cost savings for the grid operator** of close to **USD 1.32 billion**². These savings will also benefit consumers as the distribution cost in their final bill is reduced. The savings are estimated to be realised between 2018 and 2023 (Engerati, 2018).
- UK Power Networks is planning to transition from the traditional role of electricity delivery agent to adopting a virtual power plant framework. A technology trial led to **reduced peak demand** from the grid **by 60%** (Hill, 2018).

¹ The six utilities participating in this programme are Central Hudson Gas & Electric, Consolidated Edison (ConEd), New York State Electric & Gas, National Grid New York, Orange and Rockland Utilities, and Rochester Gas and Electric.

² Original figure of GBP 1 billion converted to USD based on Bloomberg's quote for the GBP-USD exchange rate on 10 July 2018 (<https://www.bloomberg.com/quote/GBPUSD:CUR>).

III. KEY FACTORS TO ENABLE DEPLOYMENT

Multiple aspects need to be changed to facilitate the transition of distribution companies from traditional distribution network owners and operators to a more active role as distribution system operators and market facilitators.

Firstly, the regulatory framework needs to define clear roles and responsibilities for DSOs and to incentivise innovation. Secondly, there is a need to standardise the collection and sharing of data by DSOs as this will be crucial in providing value-added services to consumers, as well as enabling successful system operation and management. Lastly, smart hardware backed by communication infrastructure is needed to facilitate complex interactions between DSOs and DERs.

Regulatory frameworks for the future role of DSOs

Despite the transformation of the role of DSOs, these entities will remain regulated. Therefore, regulations should allow this change by clearly defining the roles and responsibilities of DSOs, as well as of the owners of distributed energy resources. Neutrality and transparency should govern any interaction between DSOs and network users.

Further, to enable DSOs to interact with DERs and to procure flexibility services from them, appropriate regulatory frameworks must be developed. These measures should aim at developing the mechanisms that encourage innovation by DSOs, as well as developing technical specifications and amending grid codes for the provision of such services.

For example, in the UK's Office of Gas and Electricity Markets (Ofgem), the energy regulator adopted a new regulatory model called RIIO: "*setting Revenues using Incentives to deliver Innovation and Outputs*". This model has price controls for network tariffs charged by distribution network operators while providing incentives to these operators for innovation with regard to customer expectations, environmental impact, etc. The RIIO model is helping distribution network operators transition to the system operator role by encouraging innovative approaches (Ofgem, 2018).

In the state of New York, the Reforming the Energy Vision roadmap – a set of regulatory proceedings and policy initiatives – was launched in 2014 to restructure the rate-making and revenue models of state utilities so that they are better aligned with consumer interests and allow for the integration of DERs (New York State, n.d.).

Standards for data management

For DSOs to securely share customer data with third parties and market participants, standards for data management and data sharing need to evolve. Data management arrangements should serve to protect the privacy of personal data, and customers should be able to determine how their data is used.

For example, in the US state of Washington, the Public Utility Districts have released guidelines for ensuring data privacy of consumers. These guidelines mandate utilities to get permission from consumers for the collection of private data and its disclosure to third parties (WPUDA, 2016).

Smart grids and digital technologies

In the future, DSOs will need to develop innovative systems to solve network constraint issues and to manage the injection of variable power. This can be enabled through enhanced use of information and communication technologies (ICTs). The emergence of advanced digital technologies such as sensors, smart meters, artificial intelligence and robotics has unlocked new and efficient ways of managing the network. These solutions comprise, among others, automated voltage control or automatic grid reconfiguration to reduce the loading of a distribution feeder by transferring part of the distributed generation feed-in to a neighbouring one. Grid networks enabled by such technologies are often referred to as smart grids.

The deployment of smart grid technologies can enable enhanced interaction of DSOs with consumers and DERs, which is key for a system operator. The most straightforward approach is mandating DER units to comply with certain communication requirements and dispatch signals sent by the DSO. Implementation of these digital technologies also can enable the real-time exchange of information between DSOs and DERs.

One of the ways to encourage large-scale adoption of smart grid technologies is through regulatory frameworks. For example, the European Commission has mandated that all EU Member States upgrade at least 80% of their meters to “smart” versions by the year 2020, although considerable delays are expected (thinkSPAIN, 2017). The UK plans to deploy smart meters to approximately 50 million households by 2020 (Nhede, 2018).

Italy, a leader in the deployment of smart meters, has over 30 million smart metering devices in operation. Driven by EU energy efficiency requirements (European Directive 2012/27/EU), e-Distribuzione, a power distributor in Italy, is in the process of replacing the country’s current smart meters with second-generation smart meters that reflect the evolution in the field of metering and remote management. These new meters will make it possible to promote energy efficiency, increase awareness of consumption behaviour, encourage competition in post-meter services and develop a home automation market (Engerati, 2017).

Improving communication with consumers

As the role of DSOs evolves, they also need to engage consumers better through improved communication. DSOs will need to respond to a new generation of customers – who are now able to engage with their banks through web chats, order taxis using smartphones and talk to various service providers over social media – without neglecting customers who are not familiar with the new technologies.

DSOs therefore will need to focus increasingly on digital media capabilities for customer interaction and engagement. For instance, DSOs in Spain, such as Iberdrola and Endesa, have developed smartphone applications that allow consumers to check their hourly consumption, submit their real meter readings, manage their contracts and pay bills (Endesa, 2018; Iberdrola, 2018).



IV. CURRENT CONTEXT AND LEADING INITIATIVES

Key facts about the emerging role of DSOs presented in Table 1, followed by some pilot projects.

Table 1 Key facts about the emerging role of distribution system operators

Description	Key facts
Key countries incentivising the expanded role of DSOs	Countries in European Union, US
Key transformational steps being taken by DSOs	Deployment of smart meters, real-time monitoring systems, creating a level playing field for aggregators, establishing local marketplaces, etc.
Key drivers for the transition	Network capacity deferral, local congestion management, need for voltage control in light of increasing shares of renewable energy generation
Key flexibility services being procured	Demand-side response, synthetic inertia, power quality, congestion management, voltage control, reactive power support

New York’s Reforming the Energy Vision

Under the state of New York’s Reforming the Energy Vision roadmap, the New York Public Service Commission has mandated six large investor-owned utilities to undertake several measures to integrate DERs.

These include creating charging systems for EVs, creating online marketplaces for energy products and services, building virtual power plants and enabling connectivity of DERs to the grid, and developing storage on demand, among others. The costs for these products and services will be recovered through revised tariff structures. These utilities have launched multiple demonstration projects (New York State, 2018).

United Kingdom's Open Networks Project

The UK's Open Networks project – launched by the Electricity Networks Association, a national trade association representing the transmission and distribution networks – is expected to lay the foundation for transitioning the role of DSOs. Its objectives include developing improved processes for transmission and distribution system operators, planning and shared services, and a needs gap assessment for customers (Engerati, 2018).

Western Power Distribution, a DSO in the UK, has released a four-point plan that includes expanding and rolling out smart network solutions to higher voltages, contracting with aggregators and customers for various services, TSO-DSO co-ordination and ensuring the integrity and safety of lower-voltage networks (Engerati, 2018).

Scottish and Southern Electricity Networks' (SSEN) local flexibility marketplace

SSEN, a distribution system operator in the UK, has begun trials for a new online marketplace hosted by Open Utility to procure flexibility services for local requirements. This will enable SSEN to address local network constraints by buying flexible services such as demand response and battery storage capacity. The project is expected to be commercially operable in 2019 (Grimwood, 2018).



National Grid's Enhanced Frequency Control Capability (EFCC) project

National Grid, along with six companies (Flexitricity, Belectric, Centrica, Orsted, Siemens and GE Grid Solutions) and two universities (Manchester and Strathclyde), are working on the EFCC project under which a new monitoring and control system has been developed for grid management. This system is expected to help maintain system stability during peak hours using a range of technologies, as listed below:

- Belectric will use its solar PV plants and battery storage systems to provide response.
- Centrica will use its combined-cycle gas turbines and wind farms to provide generation response.
- Orsted and Siemens will use wind turbines to provide fast frequency response and measure the associated cost for providing this service.
- Flexitricity will use commercial and industrial customers to provide demand-side response.

This project is expected to help in the development of new services for rapid frequency response (Porter, 2018).

V. IMPLEMENTATION REQUIREMENTS: CHECKLIST

<p>TECHNICAL REQUIREMENTS</p> 	<p>Hardware:</p> <ul style="list-style-type: none"> • Smart meters and smart network devices • ICT infrastructure such as fibre cables, wireless communications, etc. • Battery storage devices at the distribution level, and deployment of other DERs • Upgrading network assets to handle erratic and large reverse flows of power • Active network devices such as automatic on-load tap changers for transformers, static synchronous compensators, static var compensators, etc. <p>Software:</p> <ul style="list-style-type: none"> • Smart meter data acquisition software • Supervisory Control and Data Acquisition (SCADA) software <p>Communication protocols:</p> <ul style="list-style-type: none"> • Develop common interoperable standards (at both physical and ICT layers) to increase co-ordination among aggregators, DSO, TSO and consumers
<p>REGULATORY REQUIREMENTS</p> 	<p>Retail market:</p> <ul style="list-style-type: none"> • Regulations to mandate implementation of smart meters and smart grid infrastructure, where the cost-benefit analysis is positive • Clear price signals in place to guide prosumers' behaviour <p>Distribution system:</p> <ul style="list-style-type: none"> • Regulations incentivising DSOs to actively manage the grid • Data collection, management and sharing rules for DSOs to ensure consumer privacy <p>System operation:</p> <ul style="list-style-type: none"> • Defining rules for DSO-TSO co-ordination between transmission and distribution system operators
<p>STAKEHOLDER ROLES AND RESPONSIBILITIES</p> 	<p>Distributed energy resource owners (e.g., aggregators):</p> <ul style="list-style-type: none"> • Provide grid-related services to DSOs, if a market is established • Information exchange with DSOs related to capacity, location, type of DERs <p>Distribution system operators:</p> <ul style="list-style-type: none"> • Ensure a level-playing field for all flexibility providers • Procure market-based flexibility services from DERs • Securely share consumer and grid-related data with third parties as per applicable data privacy and sharing norms • Better forecasts for DER services based on past data or historical performance and weather forecasts

ABBREVIATIONS

AMI	Advanced metering infrastructure	ICT	Information and communication technology
BtM	Behind-the-meter	TSO	Transmission system operator
DER	Distributed energy resource	VPP	Virtual power plant
DSO	Distribution system operator	VRE	Variable renewable energy
EV	Electric vehicle		

BIBLIOGRAPHY

EC (2018), “Commission welcomes political agreement on conclusion of the Clean Energy for All Europeans package”, European Commission, Brussels, http://europa.eu/rapid/press-release_IP-18-6870_en.htm.

EC (2016), Proposal for a directive of the European parliament and of the Council on Common rules for the internal market in electricity, European Commission, Brussels.

EC (2015), Study on the effective integration of Distributed Energy Resources for providing flexibility to the electricity system, Final report to The European Commission, Ecofys, Tractebel, Sweco, Brussels.

Endesa (2018), “Endesa Clients Application”, <https://www.endesaclientes.com/app-endesa-en.html>.

Engerati (2018), “UK networks: Making the switch from DNO to DSO”, <https://www.engerati.com/article/uk-networks-switch-dno-dso-western-power-distribution>.

Engerati (2017), “Italy’s smart meter rollout gets financial boost”, <https://www.engerati.com/article/italy%E2%80%99s-smart-meter-rollout-gets-financial-boost>.

Grimwood, T. (2018), “SSEN to trial new marketplace for local flexibility”, UtilityWeek, <https://utilityweek.co.uk/ssen-to-trial-new-marketplace-for-local-flexibility>.

Hancher, L. and B. M. Winters (2017), The EU Winter Package: Briefing paper, Allen & Overy, Amsterdam, <http://fsr.eui.eu/wp-content/uploads/The-EU-Winter-Package.pdf>.

Hill, J. S. (2018), “Solar & batteries to power London’s first ‘virtual power station’”, CleanTechnica, <https://cleantechnica.com/2018/06/26/solar-batteries-to-power-londons-first-virtual-power-station>.

Iberdrola (2018), “Introducing the new Iberdrola app”, <https://www.iberdrola.es/en/information/ventajas-app-en>.

IRENA (2019), *Innovation landscape for a renewable-powered future*, International Renewable Energy Agency, Abu Dhabi, <http://www.irena.org/publications/2019/Feb/Innovation-landscape-for-a-renewable-powered-future>.

New York State (2018), “REV – Demonstration projects”, <http://www3.dps.ny.gov/W/PSCWeb.nsf/All/B2D9D834B0D307C685257F3F006FF1D9?OpenDocument>.

New York State (n.d.), “Reforming the Energy Vision”, <https://rev.ny.gov>.

Ofgem (2018), “Network regulation – the ‘RIIO’ model”, UK Office of Gas and Electricity Markets, <https://www.ofgem.gov.uk/network-regulation-riio-model>.

Porter, K. (2018), “Developing local flexibility markets”, Watt-Logic, <http://watt-logic.com/2018/06/19/local-flexibility-markets/>.

Nhede, N. (2018), “Five things you need to know about the UK smart meter rollout”, Smart Energy international, <https://www.smart-energy.com/news/uk-smart-meter-rollout-2>

thinkSPAIN (2017), “Spain will be first in Europe to fit ‘smart’ electricity meters in 100 % of homes and businesses”, <https://www.thinkspain.com/news-spain/29238/spain-will-be-first-in-europe-to-fit-smart-electricity-meters-in-100-of-homes-and-businesses>.

Trabish, H. K. (2017), “How utility data sharing is helping the New York REV build the grid of the future”, Utility Dive, <https://www.utilitydive.com/news/how-utility-data-sharing-is-helping-the-new-york-rev-build-the-grid-of-the/434972/>.

WPUDA (2016), Data privacy guidelines for large utilities, Washington Public Utility Districts Association, Olympia, Washington, <https://www.wpuda.org/assets/Energydocs/model%20data%20privacy%20guideline%20for%20large%20utilities%2009%2008%2016.pdf>.

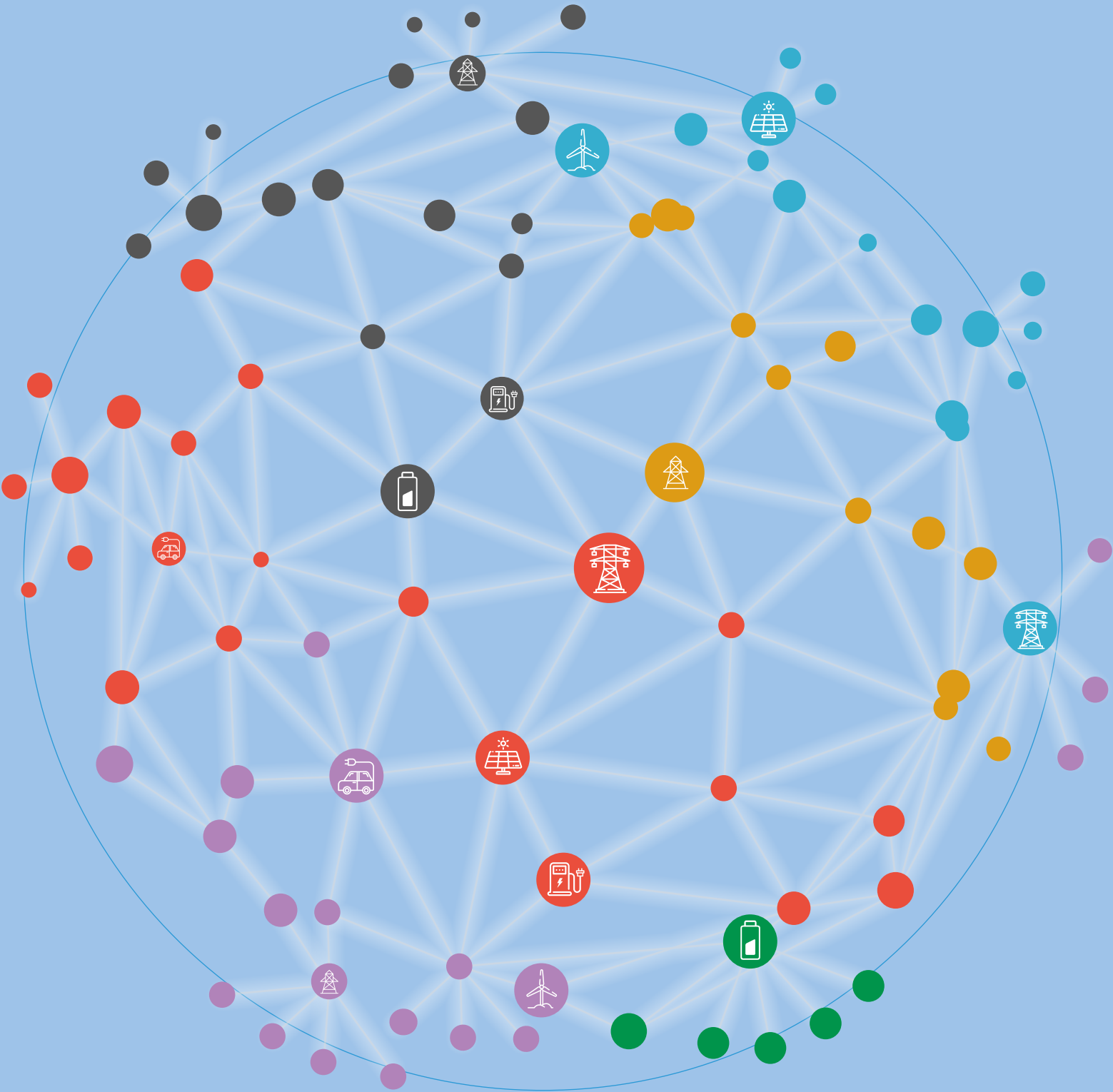

FUTURE ROLE OF DISTRIBUTION SYSTEM OPERATORS

INNOVATION LANDSCAPE BRIEF

© IRENA 2019

IRENA HEADQUARTERS

P.O. Box 236, Abu Dhabi
United Arab Emirates

www.irena.org

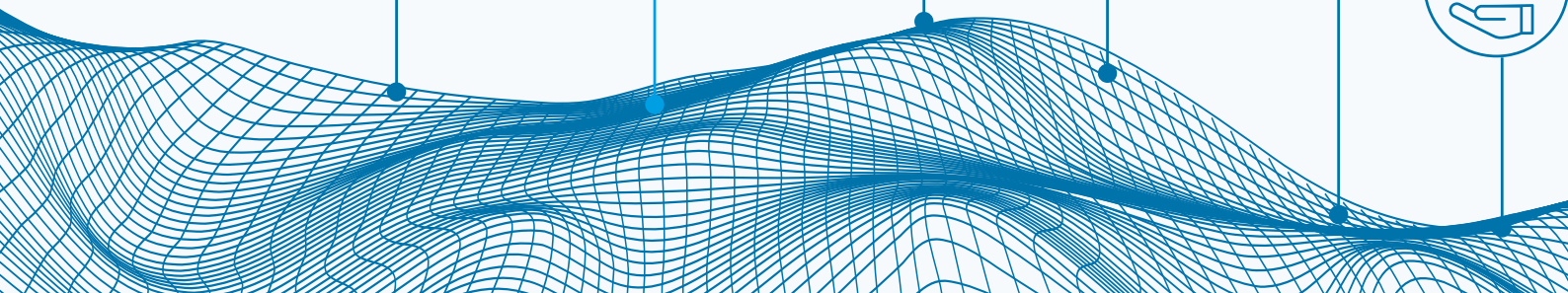

CO-OPERATION BETWEEN TRANSMISSION AND DISTRIBUTION SYSTEM OPERATORS

INNOVATION LANDSCAPE BRIEF



© IRENA 2020

Unless otherwise stated, material in this publication may be freely used, shared, copied, reproduced, printed and/or stored, provided that appropriate acknowledgement is given of IRENA as the source and copyright holder. Material in this publication that is attributed to third parties may be subject to separate terms of use and restrictions, and appropriate permissions from these third parties may need to be secured before any use of such material.

ISBN 978-92-9260-178-2

Citation: IRENA (2020), *Innovation landscape brief: Co-operation between transmission and distribution system operators*, International Renewable Energy Agency, Abu Dhabi.

ABOUT IRENA

The International Renewable Energy Agency (IRENA) is an intergovernmental organisation that supports countries in their transition to a sustainable energy future and serves as the principal platform for international co-operation, a centre of excellence, and a repository of policy, technology, resource and financial knowledge on renewable energy. IRENA promotes the widespread adoption and sustainable use of all forms of renewable energy, including bioenergy, geothermal, hydropower, ocean, solar and wind energy in the pursuit of sustainable development, energy access, energy security and low-carbon economic growth and prosperity. www.irena.org

ACKNOWLEDGEMENTS

This report was prepared by the Innovation team at IRENA's Innovation and Technology Centre (IITC) and was authored by Arina Anisie and Francisco Boshell, with additional contributions and support from Harsh Kanani and Anusha Rajagopalan (KPMG India).

Valuable review was provided by Helena Gerard (VITO), Samuel Newell (the Brattle Group), Nilmini Silva-Send (Energy Policy Initiatives Center – EPIC), Pedro Godinho Matos (EDP), Jörn Richstein (German Institute for Economic Research – DIW Berlin) and Gianluigi Migliavacca (RSE), along with Carlos Fernández, Gayathri Nair, Laura Casado, Elena Ocenic, Nina Litman-Roventa, Martina Lyons and Paul Komor (IRENA).

DISCLAIMER

This publication and the material herein are provided “as is”. All reasonable precautions have been taken by IRENA to verify the reliability of the material in this publication. However, neither IRENA nor any of its officials, agents, data or other third-party content providers provides a warranty of any kind, either expressed or implied, and they accept no responsibility or liability for any consequence of use of the publication or material herein.

The information contained herein does not necessarily represent the views of all Members of IRENA. The mention of specific companies or certain projects or products does not imply that they are endorsed or recommended by IRENA in preference to others of a similar nature that are not mentioned. The designations employed and the presentation of material herein do not imply the expression of any opinion on the part of IRENA concerning the legal status of any region, country, territory, city or area or of its authorities, or concerning the delimitation of frontiers or boundaries.

Photographs are from Shutterstock unless otherwise indicated.

This document does not represent the official position of IRENA on any particular topic. Rather, it is intended as a contribution to technical discussions on the promotion of renewable energy.

1 BENEFITS

Increased interaction between distribution system operators (DSOs) and transmission system operators (TSOs) can enable:

- Better utilisation of distributed energy resources (DERs)
- Increased system flexibility
- Optimisation of investments in grid infrastructure

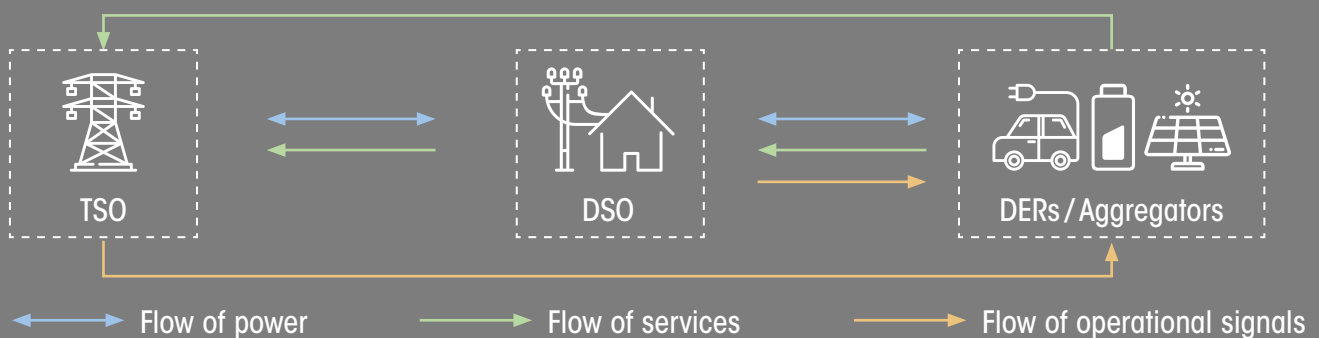

2 KEY ENABLING FACTORS

- ↔ Introduction of data exchange platforms
- 🔌 Digitalisation
- 📄 Clearly defining the new role of DSOs

3 SNAPSHOT

- Various TSO-DSO co-operation projects have been piloted in the European Union
 - 🌐 SmartNet project includes Denmark, Italy and Spain
 - 🌐 CoordiNet project includes Greece, Spain and Sweden
- Colombia is also looking at increasing TSO-DSO co-operation in the context of increased distributed generation

TSO-DSO CO-OPERATION

Improved co-ordination between transmission and distribution system operators becomes essential to integrate distributed energy resources and gain maximum system flexibility.

ABOUT THIS BRIEF

This brief forms part of the IRENA project “Innovation landscape for a renewable-powered future”, which maps the relevant innovations, identifies the synergies and formulates solutions for integrating high shares of variable renewable energy (VRE) into power systems.

The synthesis report, “*Innovation landscape for a renewable-powered future: Solutions to integrate variable renewables*” (IRENA, 2019a), illustrates the need for synergies between different

innovations to create actual solutions. Solutions to drive the uptake of solar and wind power span four broad dimensions of innovation: enabling technologies, business models, market design and system operation.

Along with the synthesis report, the project includes a series of briefs, each covering one of 30 key innovations identified across those four dimensions. The 30 innovations are listed in the figure below.

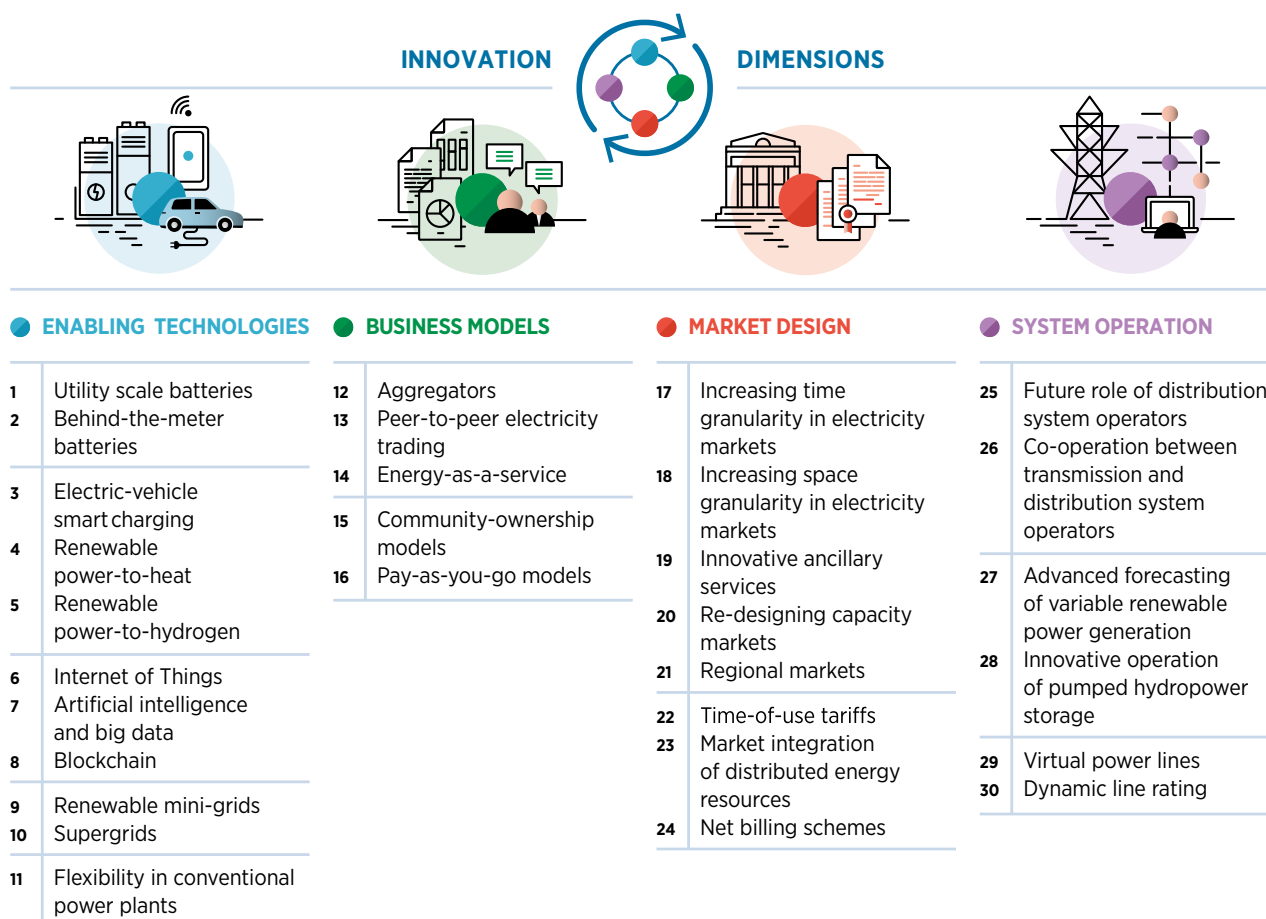

While in some power systems, generation, transmission and distribution of power are performed by a single vertically integrated (and sometimes state-owned) organisation, in other power systems these functions are performed by separate organisations. This innovation landscape brief applies mainly to power systems in which the transmission and distribution of power are the responsibility of two distinct entities.

This brief provides an overview of co-operation between transmission system operators (TSOs) and distribution system operators (DSOs) to integrate distributed energy resources (DERs) into the grid to achieve a higher penetration of renewable energy in the entire system. The brief further describes possible TSO-DSO co-operation schemes, as well the potential impact of such co-operation, in the context of power system decentralisation and VRE integration.

Distributed energy resources (DERs) are small or medium-sized resources, directly connected to the distribution network (EC, 2015). They include distributed generation, energy storage (small-scale batteries) and controllable loads, such as electric vehicles (EVs), heat pumps or demand response.

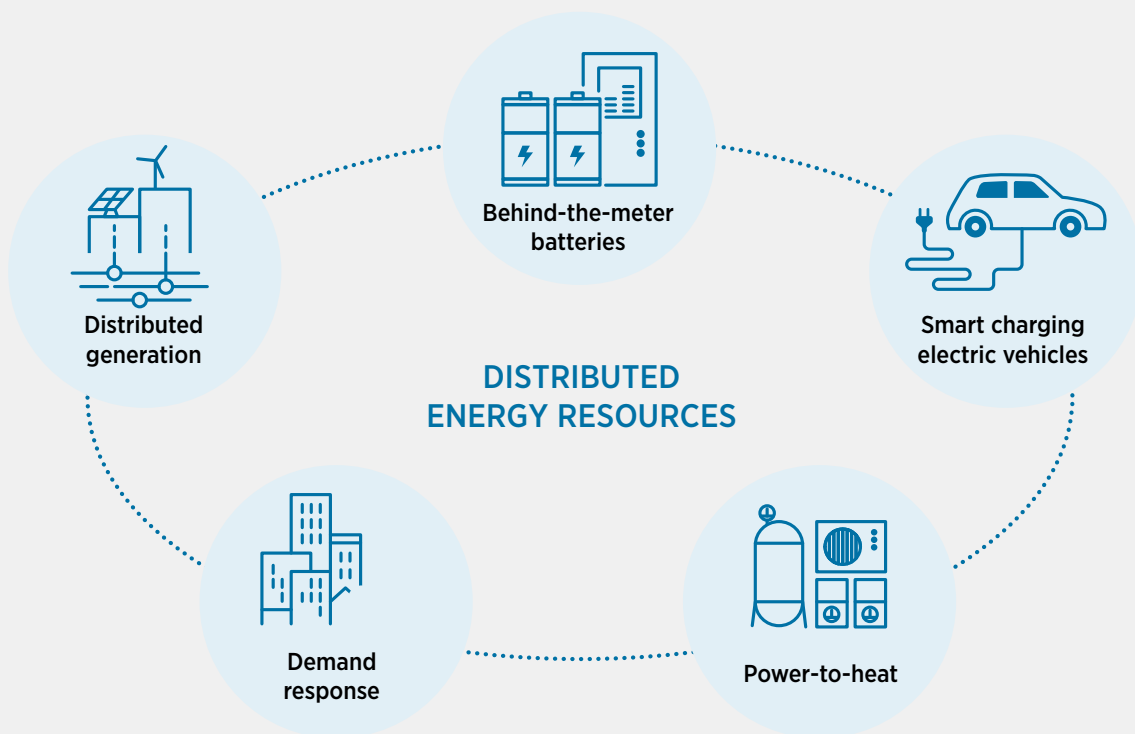

The brief is structured as follows:

- I Description
- II Contribution to power sector transformation
- III Key factors to enable deployment
- IV Current status and examples of ongoing initiatives
- V Implementation requirements: Checklist

I. DESCRIPTION

In the traditional model of centralised power generation, the flow of electricity is unidirectional, that is, from power plants to end consumers through power transmission and distribution networks. Traditionally, the TSO¹ has been responsible for operating the electricity transmission network and transporting electricity from centralised generation facilities to regional/local distribution networks to meet the demand of various DSOs. These are, in turn, responsible for delivering reliable and secure power to end users within specified constraints of voltage and frequency.

The deployment of renewable generation technologies connected to the distribution network has resulted in the bi-directional flow of electricity through the network. In addition, the emergence of distributed storage and demand response practices has also changed the net load and flows in the system. In this new context, with the deployment of DERs, the role of the DSO needs to expand to harness the flexibility offered by these new technologies on the distribution system. If the regulatory framework allows it, DSOs can themselves operate the DERs, or they can act as neutral market facilitators and provide high-resolution price signals to the market players that own flexibility assets, supporting the TSOs.

The roles of, and interaction processes between, DSOs and TSOs need to be redefined to increase the integration of DERs within the power system. This is particularly the case in systems where there is a lack of clear distinction between their respective responsibilities in the new context of increasingly decentralised systems. At the same time, congestion on the network needs to be managed and reduced, and the system as a whole needs to be balanced in an optimal way.

DSOs should evolve from the traditional operational approach to DERs, known as “connect and forget”, to being neutral market facilitators, enabling DERs to provide services to the system by participating in wholesale markets. Increased co-operation between DSOs and TSOs becomes central in this new paradigm (see the *Innovation Landscape Brief: Future role of distribution system operators* [IRENA, 2019b]).

Figure 1 summarises possible interactions between DSOs, TSOs and DER owners, showing the flow of power, services and operational signals between them in a context where DERs are allowed to participate in electricity and ancillary service² markets.

1 Different nomenclatures are used in different regions for system operators: transmission system operator (TSO), independent system operator (ISO), independent transmission operator (ITO) or regional transmission organisation (RTO), among others. For the purpose of this brief, TSO is used to refer to any kind of entity responsible for operating the electricity transmission network.

2 “Ancillary services” are services necessary for the operation of a transmission or distribution system. Ancillary services are typically procured by TSOs and can be clustered into frequency ancillary services (balancing of the system) and non-frequency ancillary services (voltage control and black-start capability) (IRENA, 2019c).

Figure 1 Interaction model between system operators and DERs

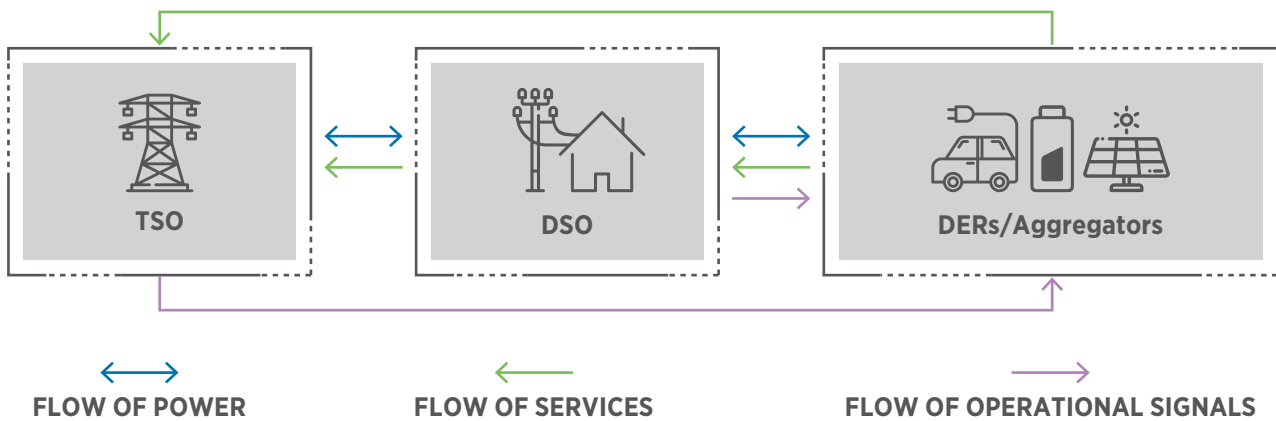

Source: Adapted from Birk et al. (2017).

Efficient co-operation between DSOs and TSOs is critical for the participation of DERs in the wholesale power markets. The DSOs should also act as, or enable, a data exchange platform

between TSOs and DER owners, providing visibility to the TSO on the type and availability of DERs. Figure 2 summarises some of the key areas of co-ordination between TSOs and DSOs.

Figure 2 Important areas of co-ordination between TSO and DSO

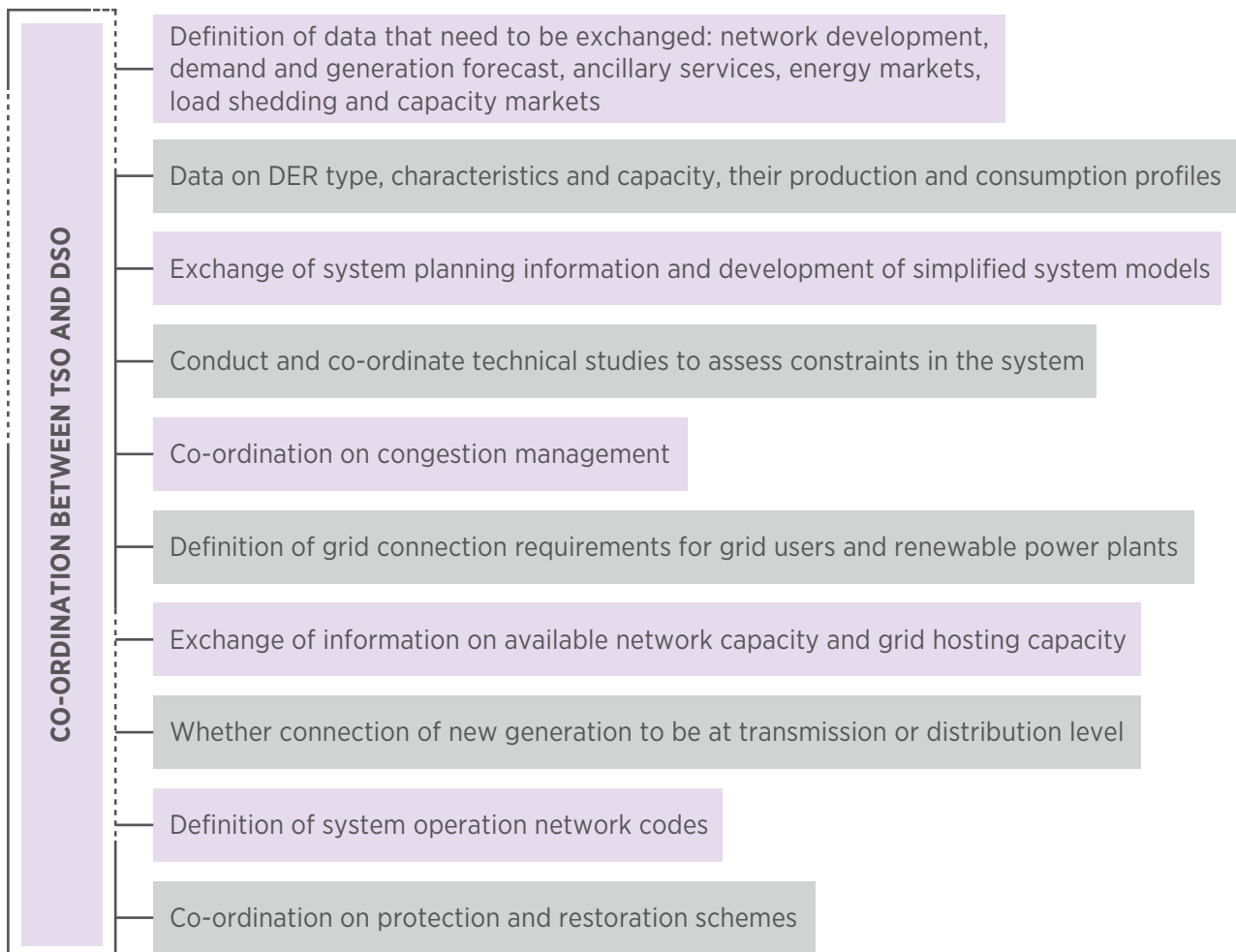

Source: IRENA (forthcoming a).

Possible co-ordination schemes between DSO and TSO for the procurement of ancillary services from DERs

For the efficient operation of a grid with a significant share of electricity from DERs, information sharing between TSOs and DSOs is essential to maximise the benefits that DERs can provide to the system and facilitate their integration into the system. Information sharing between TSOs and DSOs allows them to identify where connected entities can and should take action to support the needs of the power system. Any co-operation scheme

should be well designed and implemented so that the actions taken by the DSO and TSO do not have counteracting effects (Migliavacca, 2018a).

The European Union-funded project “SmartNet” has identified five different models for system operators to co-ordinate the participation of DERs in the ancillary service market. The schemes are listed in Table 1. The co-ordination models differ according to the market design and the responsibilities of the system operators in the market. While these models correspond to five types of interaction, many variants of them are possible.

Table 1 Co-ordination models for TSOs and DSOs in Europe

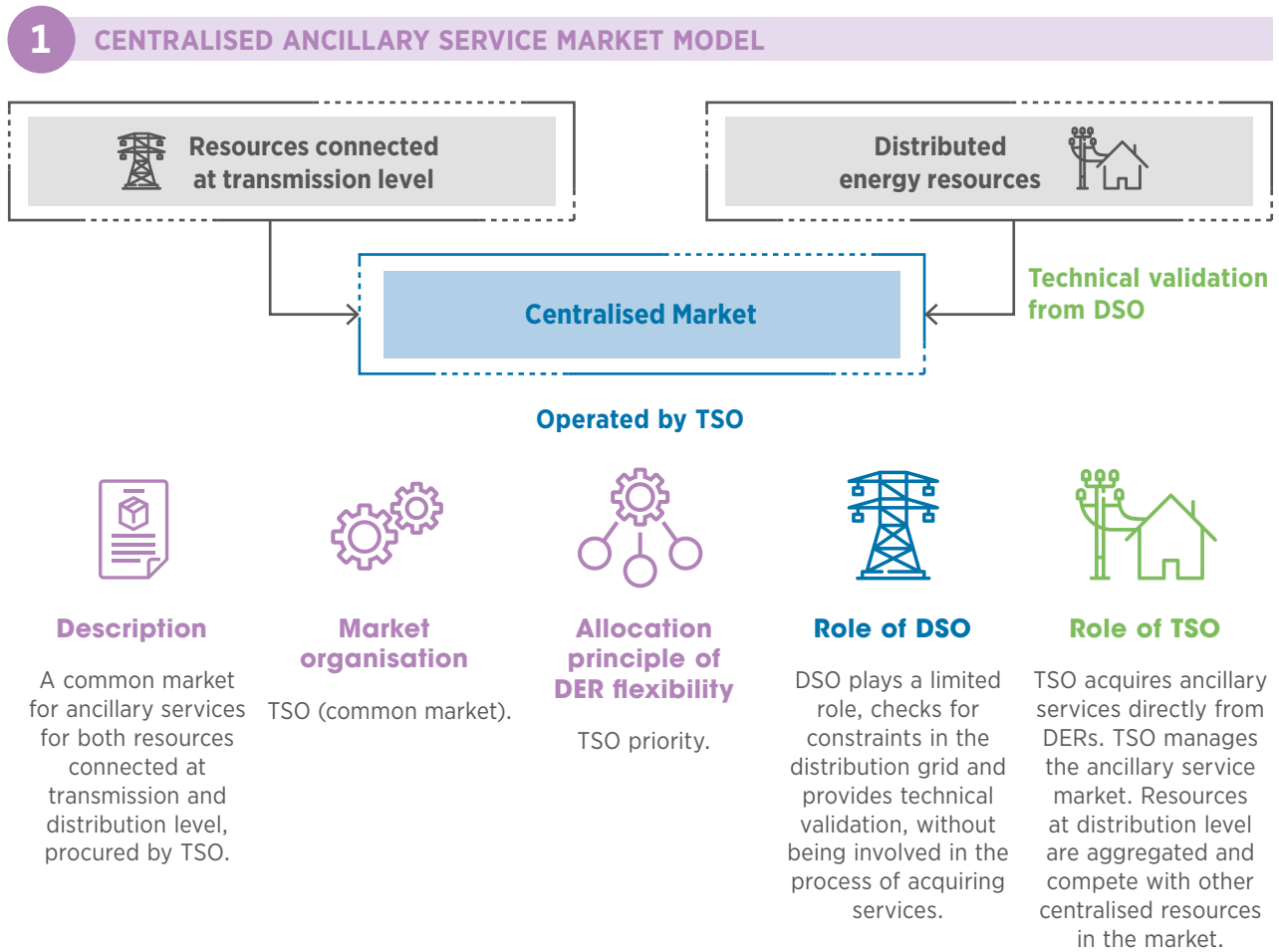

BENEFITS

- Optimal scheme if distribution networks do not experience significant congestion.
- A single market has low operational costs and allows standardised processes.
- Easier to implement under current regulatory frameworks.
- Easiest computational complexity as only the transmission grid is considered.

CHALLENGES

- Distribution grid constraints are not always respected.

2 LOCAL ANCILLARY SERVICE MARKET MODEL

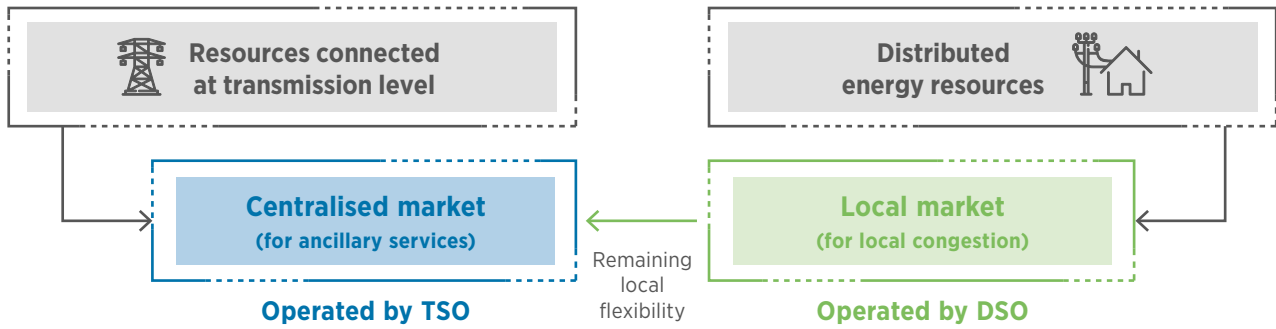

Description

Separate local flexibility market for DSOs, in addition to the ancillary services market for TSO procurement.



Market organisation

TSO (centralised market) and DSO (local market).

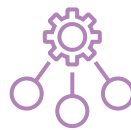

Allocation principle of DER flexibility

DSO priority.



Role of DSO

DSO operates a local market for resources connected at DSO level and is responsible for local congestion management. DSO has priority to use the flexible resources on the local grid. DSO aggregates and transfers the remaining bids to the TSO market after all local constraints are resolved, while ensuring that only bids respecting DSO grid constraints can take part in the ancillary services market.



Role of TSO

TSO manages the central ancillary services market and can only acquire the remaining local flexibility from DSO with technical validation from DSO to ascertain feasibility of the orders.

BENEFITS

- DSO has priority to use local flexibility.
- DSO actively supports ancillary service procurement.
- Local markets can have lower entry barriers for small-scale DERs.





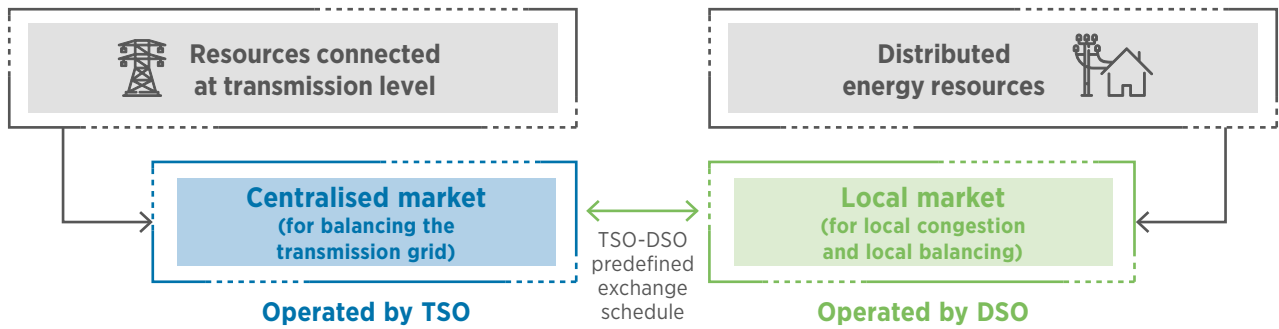

CHALLENGES

- Centralised and local market cleared sequentially.
- Need for extensive communication between the centralised market and the local market.
- Local market should have of a “reasonable” size and guarantee a sufficient number of actors are in competition in order to prevent scarcity of liquidity and exercise of local market power.

3 SHARED BALANCING RESPONSIBILITY MODEL



 <p>Description</p> <p>Similar model to the local flexibility market model with the exception that the remaining local flexibility is not offered on to TSO.</p>	 <p>Market organisation</p> <p>TSO (central market) and DSO (local market).</p>	 <p>Allocation principle of DER flexibility</p> <p>DSO only.</p>	 <p>Role of DSO</p> <p>Flexibility from the distribution grid is reserved exclusively for DSO to fulfil its responsibilities with respect to local grid constraints and local grid balancing. DSO autonomously provides balancing services and congestion management for local grid based on a predefined exchange schedule between DSO and TSO.</p>	 <p>Role of TSO</p> <p>TSO is responsible for resources connected at the transmission level, resulting in a separation of roles and responsibilities at individual TSO-DSO interconnection points.</p>
--	---	--	--	--

BENEFITS

- TSO will need to procure a lower amount of ancillary services.
- Local markets can have lower entry barriers for small-scale DERs.
- Clear boundaries between TSO and DSO responsibilities.

CHALLENGES

- Defining a schedule methodology agreed by both TSO and DSO might be challenging.
- Local congestion markets should have a “reasonable” size and guarantee a sufficient number of actors are in competition in order to prevent scarcity of liquidity and exercise of local market power.
- Total amount of ancillary services procured by TSO and DSO together will be higher in this scheme.



4 COMMON TSO-DSO ANCILLARY SERVICE MARKET MODEL



Description

Common market for flexible resources connected at the transmission and distribution level, with allocation of flexibility to the system operator with the highest need.



Market organisation

TSO and DSO (common market).



Allocation principle of DER flexibility

Cost-minimisation for TSO and DSO.



Role of DSO & TSO

FDSO and TSO jointly manage a common ancillary services or flexibility market. The flexibility resources are acquired jointly or in co-operation so that total system cost is minimised.

BENEFITS

- Total system costs for ancillary services are minimised.
- TSO and DSO collaborate closely, making optimal use of the available flexible resources.



CHALLENGES

- Allocation of costs between TSO and DSO might be challenging.
- High computational complexity since constraints on both transmission and distribution grids are resolved in a single mechanism.

5 INTEGRATED FLEXIBILITY MARKET MODEL

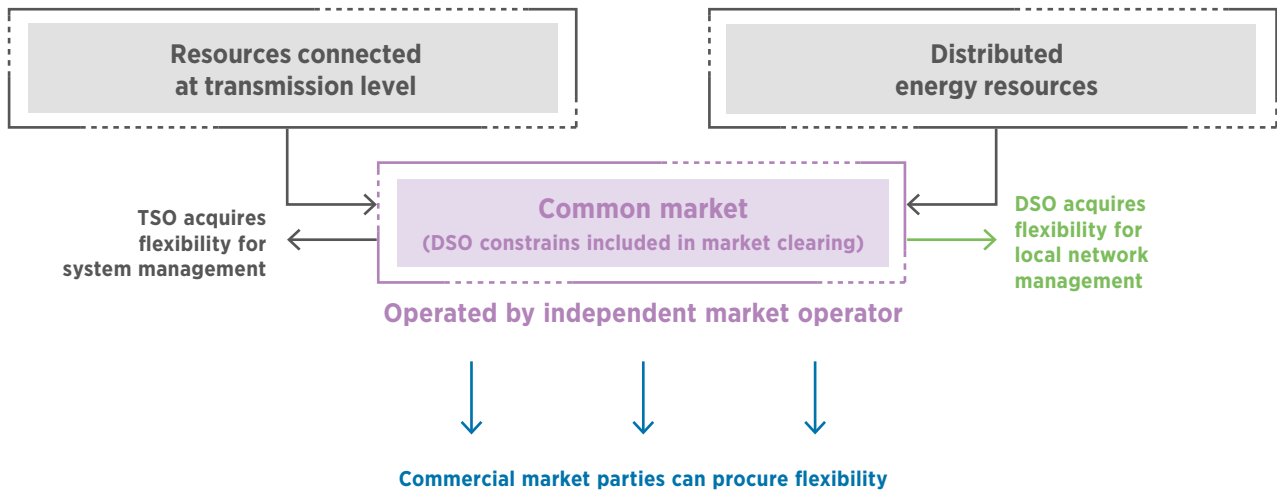

Description	Market organisation	Allocation principle of DER flexibility	Role of DSO	Role of TSO
Common market for flexible resources connected at the transmission and distribution level. Both regulated (system operators) and commercial market parties participate to procure flexibility. It is the most complex model proposed.	Independent market operator (common market).	Highest willingness to pay (market forces) dictates how flexibility is allocated.	FDSO manages the local network by acquiring flexible resources managed by an independent market operator. DSO provides technical validation to support the power flows. This is similar to the common DSO-TSO ancillary services market, with the additional possibility for commercial market parties to regulate their position in real time.	TSO also acquires resources for network flexibility from the independent market operator. The market operator allocates resources to the highest bidder.

BENEFITS

- High liquidity and competitive prices due to large number of buyers and sellers.
- Increased options for balancing responsible parties to solve imbalances.

CHALLENGES



- An independent market operator needs to be established to operate the common market.
- TSO and DSO need to share data with the independent market operator.
- High computational complexity since constraints on both transmission and distribution grids are resolved in a single mechanism.

Source: Adapted from Kockar (2017); Gerard (2017); Migliavacca (2018); SmartNet (2019).

II. CONTRIBUTION TO POWER SECTOR TRANSFORMATION

Greater interaction between DSOs and TSOs enables better utilisation of DERs in the system and increases system flexibility, while reducing expenditures on network reinforcement. The critical factor is data sharing on the capabilities of DERs connected to the distribution grid between system operators who manage real-time markets. This results in the efficient management of the wholesale and ancillary services markets.

TSO-DSO co-ordination is vital to streamline flexibility requirements, synergise planning and reduce network investment costs. The main contributions to power sector transformation from increased co-operation between DSOs and TSOs are highlighted in Figure 3.

Figure 3 Key contributions of TSO-DSO co-ordination to power sector transformation

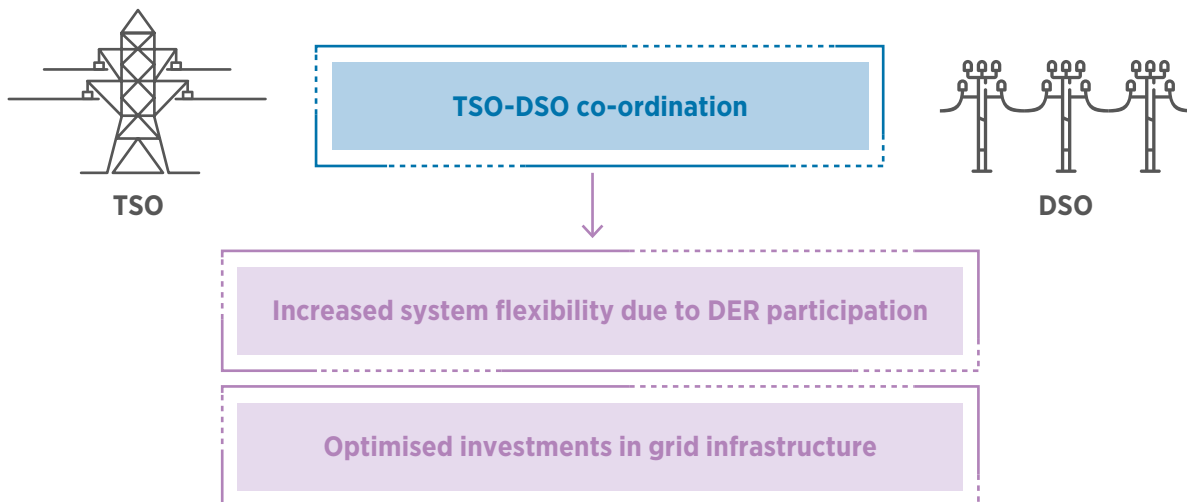

Increased system flexibility due to DER participation

Typically, TSOs have no information about the resources connected at the distribution level, such as capacity, type, characteristics, generation and consumption patterns. As the number of DERs is expected to increase with more connected devices, such as EVs, distributed solar photovoltaic (PV) systems and heat pumps, the TSO's lack of visibility over DERs can lead to load and generation forecasting errors, which can affect the reliability of the system.

Each system operator, TSO and DSO, is responsible for the operational security and quality of supply in its own networks, and should therefore be entrusted to monitor and interact with its respective grid users. In the case of DSOs, they should interact with the stakeholders connected to their grid and gather the data collected via smart meters (generators, consumers and other DSOs).

By channelling the data and sharing it with the TSO, the TSO will have increased visibility of DER capabilities at any time and be able to use it to provide ancillary services. DSOs can further serve as market facilitators for DERs to provide such ancillary services to TSOs, via aggregators or a different market arrangement. This would help TSOs balance the entire system using all connected resources in the most optimal way (WindEurope, 2017).

Some Nordic countries are in the process of developing centralised data exchange platforms. At the same time, in this region and beyond, the role of system operators is shifting. Key responsibilities include the following:

- TSOs should work with DSOs and regulators to determine requirements for the visibility and active power management of DERs, due to their increasing impact on the overall operation and planning of the system.
- TSOs and DSOs should co-operate to solve congestion issues and share information about foreseen congestion. System-wide real-time operating procedures should be developed to achieve timely and efficient congestion management solutions.

Compensation to DER owners for provision of ancillary services to TSOs or DSOs can lead to an additional revenue stream. This can further incentivise other consumers to install DERs, thereby further increasing renewable energy deployment.

Optimised investment in grid infrastructure

Through increased co-operation, DSOs and TSOs can better align their network expansion plans and identify synergies that could result in significant cost savings on large infrastructure investment projects (CGI, 2017). Further, as increased DSO-TSO co-operation also enables effective utilisation of DERs in congestion management, DSOs and TSOs can defer or partly avoid investment in grid infrastructure.

To further facilitate the integration of renewable energy and customer connections, TSOs and DSOs should regularly exchange and publish information on their available network capacity at the TSO/DSO interface. This also helps project developers connect to the network in such a way that minimises the need for further network investment.



III. KEY FACTORS TO ENABLE DEPLOYMENT

Adapting the regulatory framework is key to enabling system operators to use DERs to their full potential. Regulators should define the roles of DSOs and TSOs to facilitate data collection, management and access for different stakeholders. Different co-ordination models are used in Europe, as presented in Table 1. Regulators and policy makers need to ensure that DSOs and TSOs act in a neutral and transparent manner, enabled by data exchange platforms, communication protocols and the clear allocation of roles and responsibilities between DSOs and TSOs where these entities have unbundled ownership.

Implementing data exchange platforms

In a well-functioning electricity market, one of the most critical tasks for market transparency is the sharing of consumer metering data among different stakeholders. Sharing metering data is essential for the functioning of a competitive market as it enables better decision making by DER operators, electricity retailers and other stakeholders, such as aggregators or innovative companies providing new services³. Furthermore, such digital data exchanges allow TSOs and DSOs equal access to real-time information on DER types and connected capacity, their consumption patterns and system characteristics, among other facts. Figure 4 depicts a schematic representation of such a data exchange platform.

Figure 4 Illustration of a data exchange platform

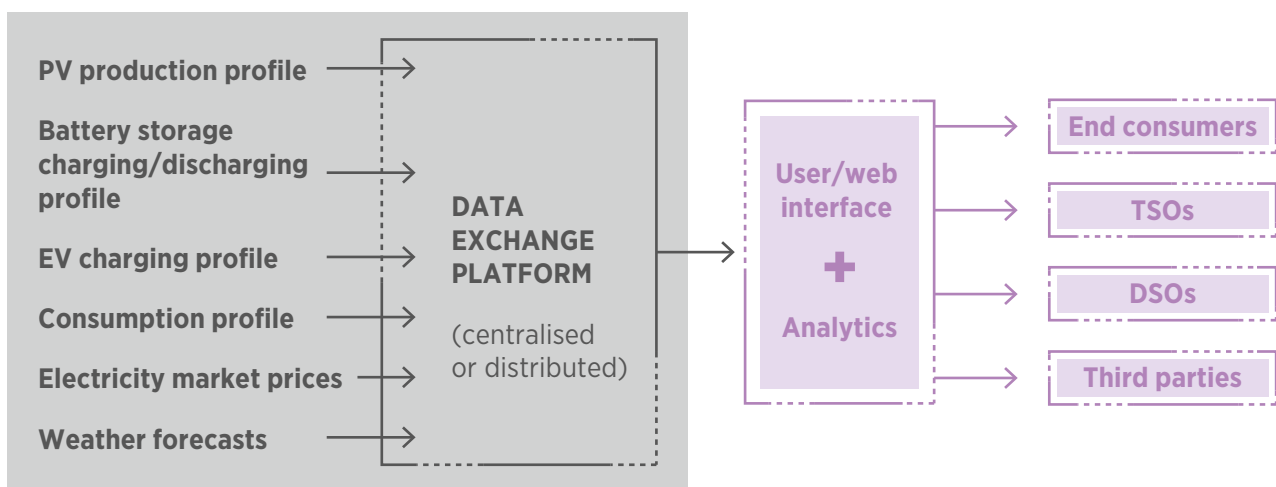

³ Energy-as-a-service (EaaS) is an innovative business model where a service provider offers various energy-related services rather than only supplying electricity. Energy service providers (ESPs) can bundle strategy, procurement, financing and energy management solutions to offer a suite of services to the customer (IRENA, forthcoming b).

The data exchange platform can be managed in a centralised or decentralised manner. A centralised data hub can be managed by system operators or a regulated third-party operator who ensures data integrity and provides non-discriminatory data access. Conversely, a decentralised platforms is managed by the local DSO, which ensures data integrity and system security. Data extracted from the data hub can be used for a variety of uses, including flexibility procurement, grid planning, system operation or network tariff determination (Thema Consulting Group, 2017).

Several European countries are planning to introduce such data exchange platforms, or data hubs, while Belgium, Denmark and Norway already have operational platforms (Table 2). In California, Silicon Valley Clean Energy launched a pilot project for an energy data exchange platform in January 2020 to demonstrate the potential of free authorised access to standardised and automated energy usage data. The platform, called UtilityAPI’s Data Exchange Platform, is the first of this kind in the United States (CALCCA, 2019).

Table 2 Status of data hub implementation

Implementation	Denmark	Belgium	Norway	California	Finland	Sweden
Status	Operational	Operational	Operational	Pilot project	Planned	Planned
Year	2013	2018	2019	2020	2021	2022

Source: Fingrid (2018); NordReg (2018), Statnett (2019); Svenska Kraftnät (2019).

Digitalisation and establishing communication protocols

Digitalisation is a prerequisite for smart grid operations and for making flexibility available through market mechanisms. The deployment of information and communications technology (ICT) and digital communication are pivotal for co-operation between the DSO and TSO, to ensure reliability of service. The cost of this transition at lower voltage levels is initially expected to be high.

Internet of Things applications, artificial intelligence and big data are critical to making the exchange of information and decision-making processes as fast and efficient as possible (for more information on digital technologies see *Innovation Landscape Brief: Internet of things* [IRENA, 2019d] and *Innovation Landscape Brief: Artificial Intelligence and Big Data* [IRENA, 2019e]).

System operators should develop communication protocols to support data exchange and interoperability on a real-time basis. This requires development of IT architecture that enables fast and secure data retrieval from the hub.

Such architecture should include all DSOs within a TSO’s network. Furthermore, given the increased data exchange, cybersecurity systems must be implemented to protect these IT systems from external attacks (CEDEC, 2016).

Determining the new role of DSOs

With the emergence of DERs, the role of the DSO itself should expand to harness the flexibility provided by these new technologies connected to the distribution system. In their new role, DSOs could operate the DERs if the regulatory framework allows it. Otherwise, DSOs could act as neutral market facilitators and provide high-resolution price signals to the market players that control the flexibility assets. In this case, an aggregator or other competitive agent would assume this function and operate the DERs according to the price signals. For example, DSOs could procure flexibility services from their network users, such as voltage support and congestion management, to defer network investment, or DSOs might provide reactive power support to TSOs (for more information see *Innovation landscape brief: Future role of Distribution System Operators* [IRENA, 2019b]).

IV. CURRENT CONTEXT AND ONGOING INITIATIVES

Policy makers and electricity market stakeholders across the world are taking the initiative to better integrate the growing number of DERs into the power system. Table 3 lists a range of initiatives to increase TSO-DSO co-operation in a European context. Initiatives that focus on increasing DER integration through better TSO-DSO co-operation are described in Table 3.

Table 3 Initiatives to increase TSO-DSO co-ordination in Europe

Description	Key facts
Regional or national plans for TSO-DSO co-operation	The European Union, as part of its Clean Energy Package for All Europeans legislative package, has issued Regulation (EU) 2019/943 on the internal market for electricity. It contains rules on co-operation between the European Network of Transmission System Operators for Electricity (ENTSO-E) and a European Entity of Distribution System Operators (EU DSO entity), which is to be established. The rules include close co-operation on the preparation, implementation and monitoring of network codes and providing guidance on the integration of distributed generation and energy storage into distribution networks or other areas that relate to the management of distribution networks. ¹
Companies participating in pilot projects for TSO-DSO co-operation	<ul style="list-style-type: none"> • TSOs: Elia, ELES, Tranelectrica, APG, MAVIR, Energinet.dk, TERNÀ. • DSOs: ENDESA, SE, Edyna, EDP. • Market design solution providers: cyberGrid GmbH (demand-side response), N-Side (developing market design for procuring ancillary services as part of SmartNet project).²
Investments made in co-ordination projects	<ul style="list-style-type: none"> • InteGrid: EUR 14.53 million³ • SmartNet: EUR 12.66 million⁴ • SINTEG: EUR 500 million (including the digitalisation of the energy sector)⁵ • CoordiNet: EUR 15 million⁶

Source: ¹EUR-Lex (2019); ²N-Side (2018); ³European Union (2016); ⁴EC (2020); ⁵BMWi (2016); ⁶Coordinet Project (2019).

Collaborative procurement of flexibility services by DSO and TSO, Belgium

The TSOs in Belgium use DERs to balance generation and demand. The DSOs assess the quality and capability of DERs before qualifying it for providing balancing services to the TSO. The TSO and DSOs collaborated to develop a central shared IT platform for sharing all data related to

procuring DERs for flexibility. It brings together all the data needed to economically assess the flexibility available, for example the consumption profiles of all grid users who opt to offer flexibility. The system calculates the quantity of energy “not consumed” or generated in a given period. This means the data hub is a critical data tool for ensuring the smooth operation of the market processes involved in providing flexibility.

The platform allows the TSO to contract flexibility, substituting the current bilateral agreements. Through this data hub, all users and generators connected to the distribution/transmission grid can provide flexibility services to TSO on a daily basis (Elia, 2018). Moreover, the TSO is given more visibility over the actions of DERs and contracting options.

SINTEG programme, Enera project, Germany

Germany's SINTEG programme, launched in 2017, aims to set up pilot or "showcase" projects demonstrating solutions to integrate high shares of energy from VRE sources, such as solar and wind, into the national grid. Under this programme, five showcase projects will be implemented at an investment of EUR 500 million. Enera, one of the five showcases, aims to develop solutions to enable DER participation in the wholesale market for ancillary services.

Enera focuses on three core areas: (a) grid management – using data to improve grid operations and create a "smart grid operator"; (b) market – improving the intraday markets to enable procurement of flexibility services from DERs to manage the distribution networks; and (c) data – building secure information and communication systems to gather and analyse data. As part of this project, EWE AG and the power market operator, EPEX SPOT, created a local market platform for system operators to procure flexibility services to manage congestion. The market platform was activated in 2018 and facilitated the first transaction in 2019 (EWE, 2018; Tix, 2019).

Energy Network Association's Open Networks Project, United Kingdom

The Open Networks Project aims to develop a smart, flexible energy system to accommodate a greater share of renewables. The key components of the project involve aiding DSOs to take up the role of a system operator and also implement mechanisms for better TSO-DSO co-ordination.

The project will detail processes, roles and responsibilities to enable co-ordination between TSO and DSOs, and will address the increasing amount of energy flowing back into the distribution grid and being exported to the transmission network. The project will also focus on improving transparency between market participants, network operators and customers, and also work on setting up a fair market framework that focuses on benefitting the entire system (Smith, 2017; Energy Network Association, 2018).

SmartNet project, Denmark, Italy and Spain

The SmartNet project is funded by the European Union's Horizon 2020 programme, with a budget of over EUR 12 million to identify models for interaction between TSOs and DSOs. The overall objective of the project is to enable data exchange between TSOs and DSOs for monitoring and acquiring DERs to provide ancillary services. The project includes designing co-operation schemes and building a simulation platform (which includes a representation of the physical network, market and information and communication systems) to enable interaction between the system operators on a pilot scale in Italy, Denmark and Spain. Beyond developing the simulation platform and three national scenarios, pilot projects are also being carried out, as follows:

- **Denmark:** The objective of this pilot is to provide data from smart meters to TSOs, DSOs and aggregators, and enable system operators to monitor and control consumption to facilitate balancing and congestion management. In this pilot, smart meter data from 30 summer houses with electrically heated indoor swimming pools is aggregated and shared with the local system operator, Syd Energi, and with the TSO, Energinet.dk.

The system operators use price signals to remotely control the electricity consumption of the swimming pools. The pools' heating schedule can be modified to solve balancing or congestion management issues faced by the system operator. The plan is to implement the model in such a way that aggregators can profitably participate in the data exchange platform. Also, the IT system is to be built so that it can obtain data from various smart meters and control a variety of thermostats.

- **Italy:** The objective of the pilot project in Italy is to aggregate real-time data on the total load and the amount of energy generated from different DER sources at the interface between TSO and DSO. This will facilitate providing ancillary services such as voltage and frequency regulation. Terna, the local TSO in Italy, is collaborating with Edyna, the DSO of the Südtirol region, on this pilot project together with the two manufacturers, SELTA and SIEMENS, to monitor and control DERs connected to the distribution grid in real time (Engerati, 2017).

In this pilot, the DSO grid is monitored in real time and information is passed on to the TSO, which manages the system in a centralised way.

The TSO is therefore informed about any limitations faced by distribution branches and can take the necessary action.

CoordiNet project, Greece, Spain and Sweden

The CoordiNet project, also funded by European Union’s Horizon 2020 programme, is developing standardised co-ordination schemes for efficient TSO-DSO co-operation to allow renewables to provide electricity grid services (Figure 5). The main objectives of the CoordiNet project are:

- Demonstrating the activation and provision of services through a TSO-DSO co-ordination platform.
- Defining and testing standard products that provide services to the network operators.

- Developing a TSO-DSO-consumer collaboration platform in demonstration areas to pave the way for the development of an interoperable pan-European market.

The project has been implemented simultaneously in Greece, Spain and Sweden starting in January 2019. It is expected to identify modifications needed to grid codes and further increase co-operation between TSOs and DSOs. The project also explores how the Internet of Things, artificial intelligence and big data, peer-to-peer energy trading platforms and blockchain technologies can facilitate the market participation of prosumers. Overall, 23 companies and institutions from 10 countries are participating in the project between 2019 and 2022 (CoordiNet Project, 2019).

Figure 5 TSO-DSO co-operation model proposed by the CoordiNet project

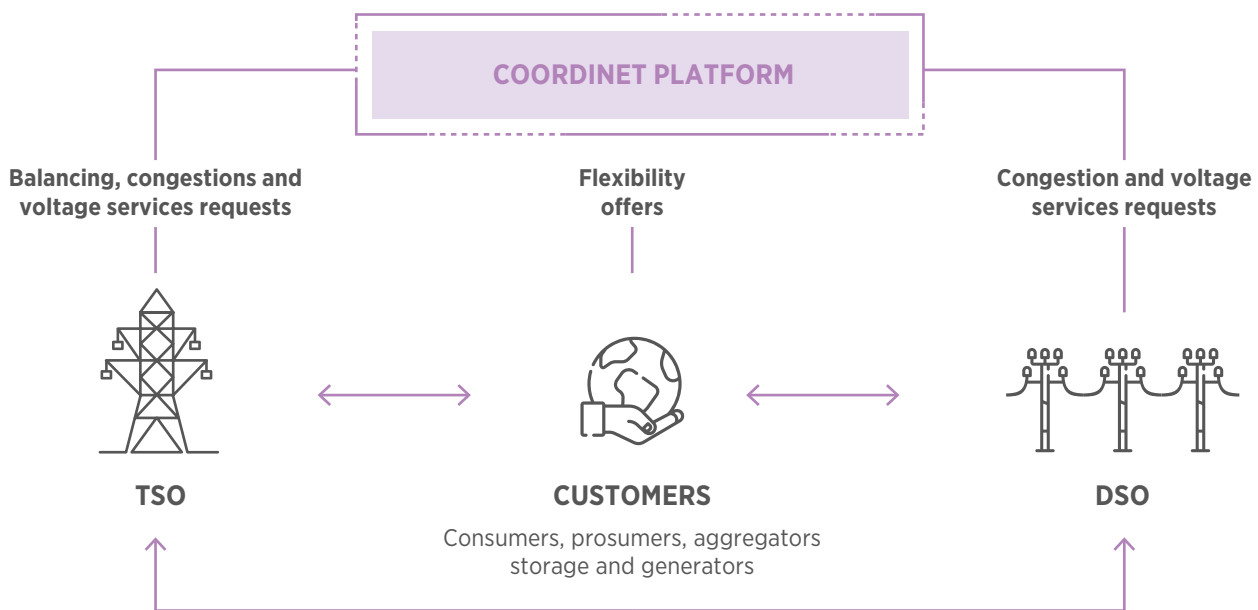



Source: CoordiNet Project (2019)

Energy transition project in Colombia

The Colombian Ministry of Energy and Mines is pursuing a project called “Mission for the Transformation and Modernisation of the Electricity Sector”, which includes adapting regulations to digitalisation, DERs and demand response. In view of the increasing DERs in the country, the project acknowledges the importance of closer co-operation between DSO and TSO for the optimal operation of the entire system.

Considering that distributed resources can provide services to both DSO and TSO, fluid co-ordination between both network operators is required – a new scenario that significantly increases the complexity of system operation. In addition to short-term co-ordination, there is also a need to co-ordinate network planning and operational functions in the long term. All this will lead to greater efficiency both in the use of networks and in the use of electricity generation and demand (MINENERGIA, 2019).

V. IMPLEMENTATION REQUIREMENTS: CHECKLIST

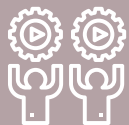
<p>TECHNICAL REQUIREMENTS</p> 	<p>Hardware:</p> <ul style="list-style-type: none"> • Smart meters and smart network devices, enabling advanced metering with bi-directional communication between metering points and aggregators/system operators. • Widespread adoption of distributed generation sources and energy storage technologies. <p>Software:</p> <ul style="list-style-type: none"> • Information technology systems that enable real-time or near to real-time data collection and exchange between different stakeholders. • Communication systems that enable price signals for frequency/voltage services between system operators and individual DERs or via aggregators. <p>Communication protocols:</p> <ul style="list-style-type: none"> • Common interoperable standards (at physical and information and communication technology level) to enable TSO-DSO co-ordination, as well as interaction with DER asset owners/operators.
<p>POLICIES NEEDED</p> 	<ul style="list-style-type: none"> • Polices to implement advanced metering infrastructure that will enable two-way communication between DERs and system operators. • Policies that define the role of system operators and their ability to access DERs for providing flexibility. • Policies focused on creating functioning markets (wholesale electricity and ancillary services markets), deploying innovative technologies and reducing system operation costs.
<p>REGULATORY REQUIREMENTS</p> 	<ul style="list-style-type: none"> • Clear regulations that ensure DSOs and TSOs act in a neutral and transparent manner in procuring services from DERs. • Regulations that turn DSOs into active and neutral market facilitators. • Regulations to share data from the hub with other market stakeholders while ensuring protection of consumer data. • Regulations to ensure data integrity and security of the data hub or data sharing platform. • Regulations that allow DSOs and/or TSOs to procure ancillary services from DERs. • Regulations that allow aggregation of DERs to enable their participation in markets or reduction of minimum bid sizes to allow individual DERs to participate.
<p>STAKEHOLDER ROLES AND RESPONSIBILITIES</p> 	<p>ADSOs and TSOs: collaborate with each other and with other stakeholders, including electricity retailers, DER owners/operators and aggregators, to gain visibility on the types and capabilities of DERs to provide ancillary services.</p> <p>TSOs and/or DSO: procure ancillary services from DER owners/operators (potentially via aggregators).</p> <p>IT solutions providers: develop ICT infrastructure; ensure data protection and system security.</p> <p>Policy makers and regulators: invest in pilot-scale projects to implement co-ordination schemes between DSOs and TSOs and ensure dissemination of results; define a vision for DER deployment and market integration, where applicable.</p>

ABBREVIATIONS

DER	Distributed energy resource	PV	Photovoltaic
DSO	Distribution system operator	TSO	Transmission system operator
EV	Electric vehicle	VRE	Variable renewable energy
ICT	Information and communications technology		

BIBLIOGRAPHY

Birk, Michael et al. (2017), “TSO/DSO co-ordination in a context of distributed energy resource penetration” (working paper), MIT, CEEPR.

BMW (2016), “Showcases demonstrating the future of the energy transition”, Energiewende, www.bmw-energiewende.de/EWD/Redaktion/EN/Newsletter/2016/21/Meldung/baake-sinteg.html.

CALCCA (2019), “Silicon Valley Clean Energy launches flagship pilot with UtilityAPI”, <https://cal-cca.org/silicon-valley-clean-energy-launches-flagship-pilot-with-utilityapi/>.

CEDEC (2016), “TSO-DSO data management report”, <http://cedec.com/files/default/entsoe-tso-dso-dmr-web.pdf>.

CGI (2017), “Central markets debate event debrief report”.

Coordinet Project (2019), The project, <https://coordinet-project.eu/projects/coordinet>.

EC (2015), “Study on the effective integration of Distributed Energy Resources for providing flexibility to the electricity system”, European Commission, https://ec.europa.eu/energy/sites/ener/files/documents/5469759000%20Effective%20integration%20of%20DER%20Final%20ver%202_6%20April%202015.pdf.

EC (2020), “Smart TSO-DSO interaction schemes, market architectures and ICT Solutions for the integration of ancillary services from demand side management and distributed generation”, European Commission CORDIS EU, <https://cordis.europa.eu/project/id/691405>.

Elia (2018), “Deployment of a datahub shared by all system operators to support electrical flexibility”, www.elia.be/~media/files/Elia/PressReleases/2018/20180308_SYN_Persbericht_Datahub_EN.pdf.

Energy Network Association (2018), Electricity Network Innovation Strategy, www.energynetworks.org/assets/files/electricity/futures/network_innovation/electricity_network_innovation_strategy/Energy%20Networks%20Association%20-%20Electricity%20Network%20Innovation%20Strategy-March%202018.pdf.

Engerati (2017), “Engerati”, www.engerati.com/system/files/presentationpdf/481.pdf.

EUR-Lex (2019), “Regulation (EU) 2019/943 of the european parliament and of the council of 5 June 2019 on the internal market for electricity”, <https://eur-lex.europa.eu/eli/reg/2019/943/oj>.

European Union (2016), “Demonstration of INTElligent grid technologies for renewables INTEgration and INTERactive consumer participation enabling INTERoperable market solutions and INTERconnected stakeholders”, <https://ec.europa.eu/inea/en/horizon-2020/projects/h2020-energy/grids/integrid>.

EWE (2018), “Energia project: EWE and EPEX SPOT to create local market platform to relieve grid congestions”, www.ewe.com/en/media/press-releases/2018/02/enera-project-ewe-and-epeX-spot-to-create-local-market-platform-to-relieve-grid-congestions-ewe-ag.

Fingrid (2018), “Fingrid Datahub Oy procures Finnish Datahub system from CGI Finland”, www.fingrid.fi/en/pages/news/news/2018/fingrid-datahub-oy-procures-finnish-datahub-system-from-cgi-finland/.

- Gerard, H., E. I. R. Puente and D. Six** (2017), “Coordination between transmission and distribution system operators in the electricity sector: A conceptual framework”, *Utilities Policy*, Vol. 50, pp. 40–48, www.sciencedirect.com/science/article/pii/S0957178717301285.
- IRENA** (forthcoming a), “Grid integration planning guide for medium-sized systems”, International Renewable Energy Agency, Abu Dhabi.
- IRENA** (forthcoming b), “Innovation landscape brief: Energy-as-a-service”, International Renewable Energy Agency, Abu Dhabi.
- IRENA** (2019a), “Innovation landscape for a renewable-powered future: Solutions to integrate variable renewables”, International Renewable Energy Agency, Abu Dhabi.
- IRENA** (2019b), “Innovation landscape brief: Future role of distribution system operators”, International Renewable Energy Agency, Abu Dhabi.
- IRENA** (2019c), “Innovation landscape brief: Innovative ancillary services”, International Renewable Energy Agency, Abu Dhabi.
- IRENA** (2019d), “Innovation landscape brief: Internet of Things”, International Renewable Energy Agency, Abu Dhabi.
- IRENA** (2019e), “Innovation landscape brief: Artificial intelligence and big data”, International Renewable Energy Agency, Abu Dhabi.
- Kockar, Ivana** (2017), “SmartNet project: TSO-DSO interaction architectures to enable DER participation in ancillary services markets”, presentation to ENA Open Networks Advisory Board Meeting, www.energynetworks.org/assets/files/electricity/futures/Open_Networks/SmartNet%20-%20ENA%20Open%20Networks%20London-Kockar-20Dec2017.pdf.
- Migliavacca, Gianluigi** (2018a), “TSO-DSO co-ordination and market architectures for an integrated ancillary services acquisition: the view of the SmartNet project”, CIGRE.
- Migliavacca, Gianluigi** (2018b), “SmartNet project: TSO-DSO interaction architectures to enable DER participation in ancillary services markets”, presentation to Future Power Market Platform – Meeting on TSO-DSO-PX Co-operation, www.diw.de/documents/dokumentenarchiv/17/diw_01.c.581101.de/magliavacca_fpm_10012018.pdf.
- MINENERGIA** (2019), “Misión para la Transformación y Modernización del Sector Eléctrico en Colombia: Foco 3 – Hoja de ruta regulatoria para un desarrollo más eficiente de los recursos distribuidos”, www.minenergia.gov.co/documents/10192/24166201/3.+Hoja+de+ruta+regulatoria+para+un+desarrollo+m%C3%A1s+eficiente+de+los+recursos+distribuidos.pdf.
- NordReg** (2018), “Implementation of data hubs in the Nordic Countries”, www.nordicenergyregulators.org/wp-content/uploads/2018/08/NordREG-Status-report-on-datahubs-June-2018.pdf.
- N-Side** (2018), “Real time market architecture issues”, www.n-side.com/smartnet-project-read-about-realtime-market-architecture-issues/.
- SmartNet** (2019), “TSO-DSO co-ordination for acquiring ancillary services from distribution grids: The Smartnet project final results”, <http://smartnet-project.eu/wp-content/uploads/2019/05/SmartNet-Booklet.pdf>.
- Smith, D.** (2017), “The TSO/DSO divide: Facilitating co-ordination”, <https://networks.online/gphsn/comment/1000477/tso-dso-divide-facilitating-ordination>.
- Statnett** (2019), “Elhub is now operational”, www.statnett.no/en/about-statnett/news-and-press-releases/news-archive-2019/elhub-is-now-operational/.
- Svenska Kraftnät** (2019), “Data Hub”, www.svk.se/en/stakeholder-portal/Electricity-market/data-hub/.
- Thema Consulting Group** (2017), “ENTSO-E”.
- Tix, Michaela** (2019), “Erster deal für verteilnetzflexibilität bei Enera”, *Energate Messenger*, www.energate-messenger.de/news/189307/erster-deal-fuer-verteilnetzflexibilitaet-bei-enera.
- WindEurope** (2017), “Enabling flexibility from distributed wind power”, <https://windeurope.org/wp-content/uploads/files/policy/position-papers/WindEurope-views-on-TSO-DSO-coordination.pdf>.

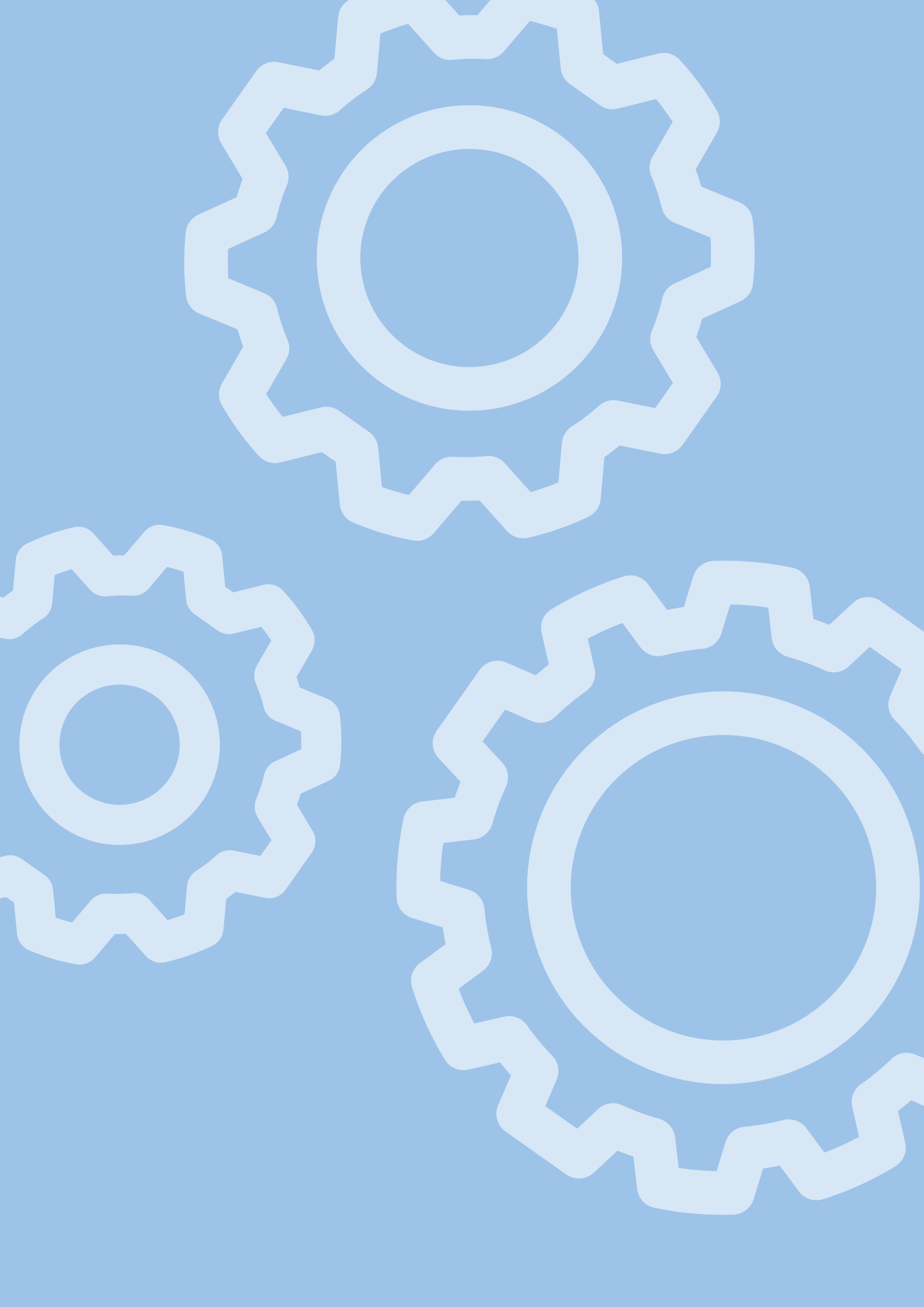

CO-OPERATION BETWEEN TRANSMISSION AND DISTRIBUTION SYSTEM OPERATORS

INNOVATION LANDSCAPE BRIEF

© IRENA 2020

IRENA HEADQUARTERS

P.O. Box 236, Abu Dhabi
United Arab Emirates

www.irena.org

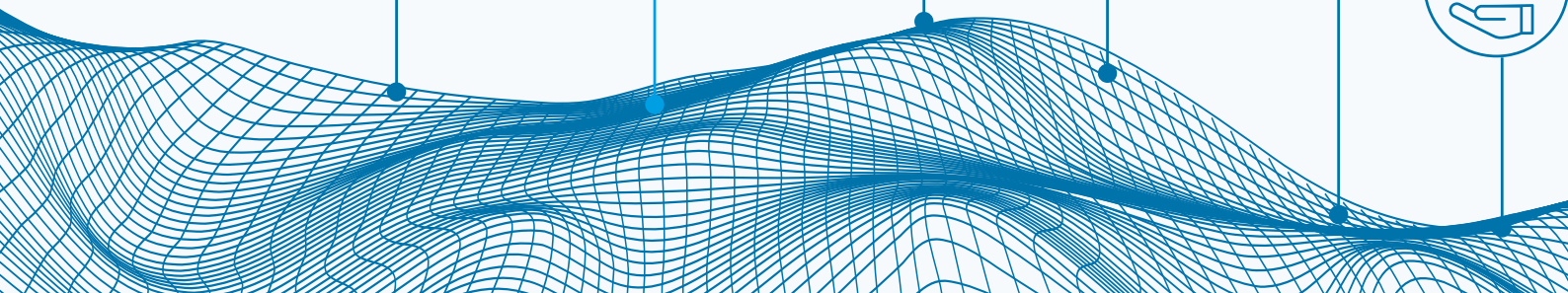
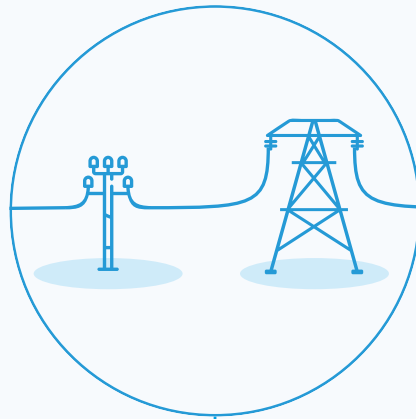

ADVANCED FORECASTING OF VARIABLE RENEWABLE POWER GENERATION

INNOVATION LANDSCAPE BRIEF

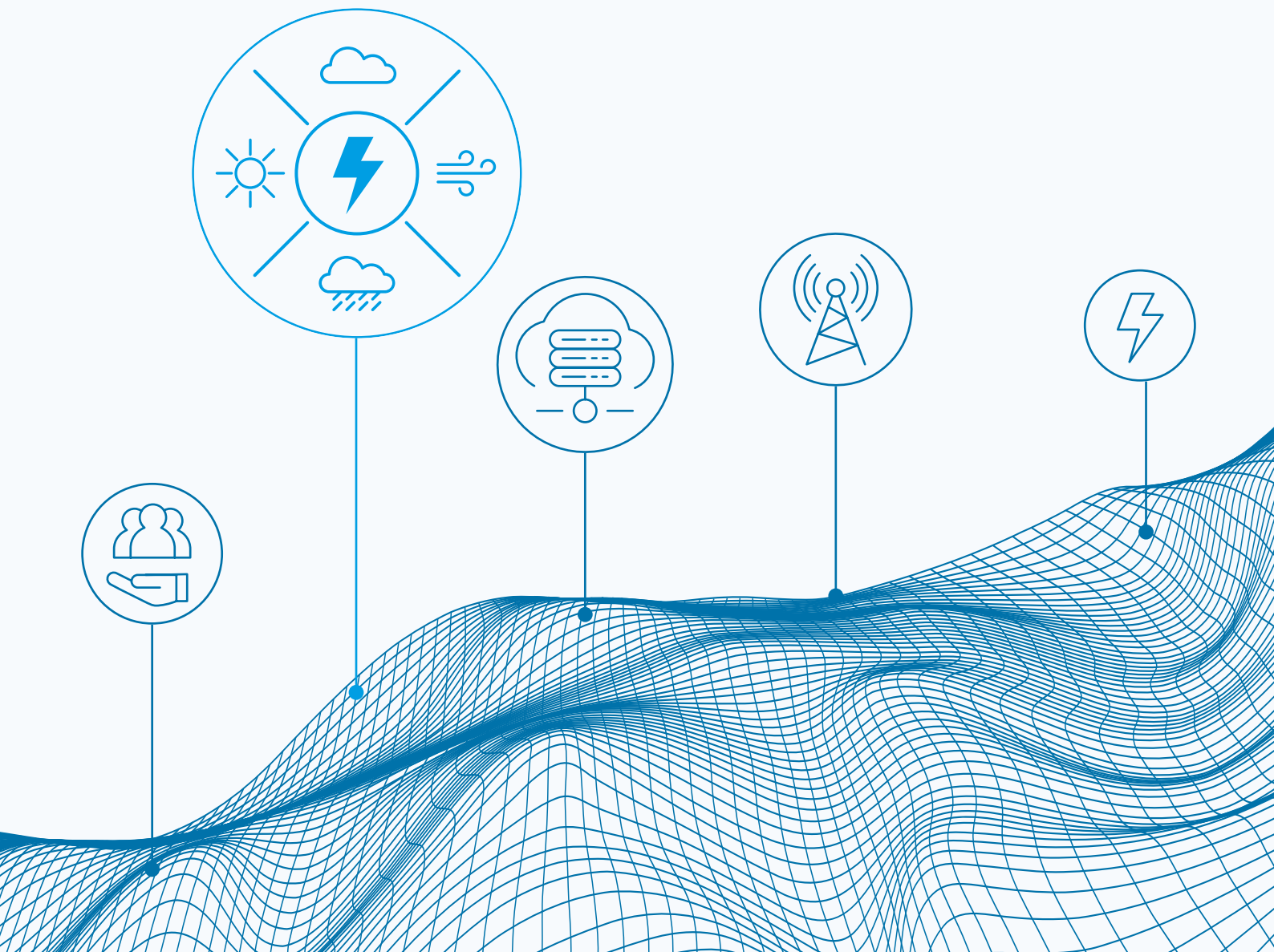

© IRENA 2020

Unless otherwise stated, material in this publication may be freely used, shared, copied, reproduced, printed and/or stored, provided that appropriate acknowledgement is given of IRENA as the source and copyright holder. Material in this publication that is attributed to third parties may be subject to separate terms of use and restrictions, and appropriate permissions from these third parties may need to be secured before any use of such material.

ISBN 978-92-9260-179-9

Citation: IRENA (2020), *Innovation landscape brief: Advanced forecasting of variable renewable power generation*, International Renewable Energy Agency, Abu Dhabi.

ABOUT IRENA

The International Renewable Energy Agency (IRENA) is an intergovernmental organisation that supports countries in their transition to a sustainable energy future and serves as the principal platform for international co-operation, a centre of excellence, and a repository of policy, technology, resource and financial knowledge on renewable energy. IRENA promotes the widespread adoption and sustainable use of all forms of renewable energy, including bioenergy, geothermal, hydropower, ocean, solar and wind energy, in the pursuit of sustainable development, energy access, energy security and low-carbon economic growth and prosperity. www.irena.org

ACKNOWLEDGEMENTS

This report was prepared by the Innovation team at IRENA's Innovation and Technology Centre (ITC) and was authored by Francisco Boshell and Arina Anisie, with additional contributions and support from Santosh Kamath, Harsh Kanani and Shikhin Mehrotra (KPMG India).

Valuable review was provided by David Moser (Eurac), Keith Parks (Xcel Energy), Ilya Chernyakhovskiy (National Renewable Energy Laboratory) and Kui Luo (State Grid Corporation of China), along with Harold Anuta, Gayathri Nair, Laura Casado, Elena Ocenic, Nina Litman-Roventá, Martina Lyons and Paul Komor (IRENA).

DISCLAIMER

This publication and the material herein are provided "as is". All reasonable precautions have been taken by IRENA to verify the reliability of the material in this publication. However, neither IRENA nor any of its officials, agents, data or other third-party content providers provides a warranty of any kind, either expressed or implied, and they accept no responsibility or liability for any consequence of use of the publication or material herein.

The information contained herein does not necessarily represent the views of all Members of IRENA. The mention of specific companies or certain projects or products does not imply that they are endorsed or recommended by IRENA in preference to others of a similar nature that are not mentioned. The designations employed and the presentation of material herein do not imply the expression of any opinion on the part of IRENA concerning the legal status of any region, country, territory, city or area or of its authorities, or concerning the delimitation of frontiers or boundaries.

Photographs are from Shutterstock unless otherwise indicated.

This document does not represent the official position of IRENA on any particular topic. Rather, it is intended as a contribution to technical discussions on the promotion of renewable energy.

1 BENEFITS

Accurate generation forecasts for solar and wind power – short term and long term, centralised and decentralised – are valuable to system operators and renewable generators.

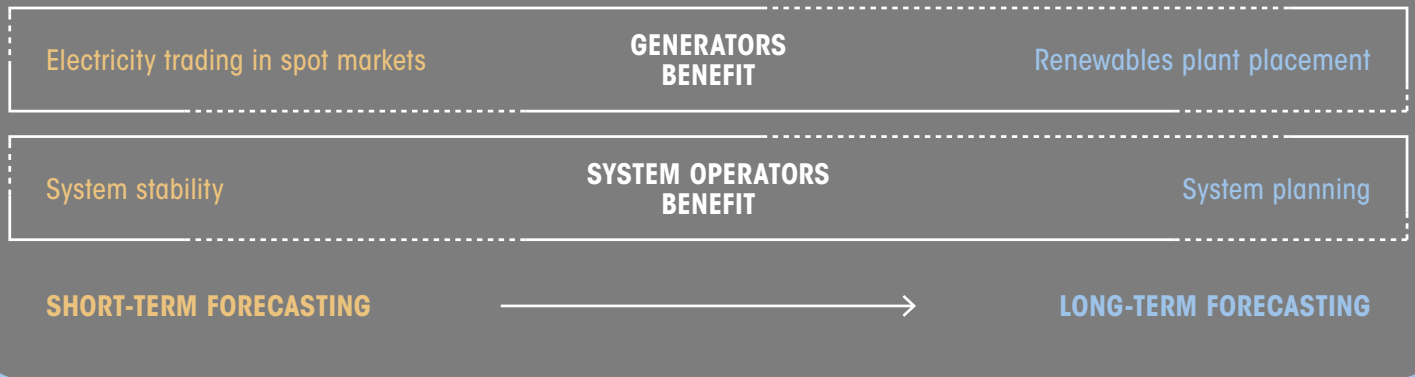

2 KEY ENABLING FACTORS

- Regulatory incentives for accurate variable renewable energy (VRE) forecasting
- Open source systems for weather data collection and sharing
- Advanced meteorological devices

3 SNAPSHOT

- Australia invests USD 5.6 million in advanced wind and solar forecasting to improve decisions made on spot markets.
- The UK system operator uses artificial intelligence to better predict renewable generation.
- A study from the California Energy Commission indicates potential savings of USD 2 million yearly with improved solar and load forecasting.

WHAT IS ADVANCED GENERATION FORECASTING?

Meteorological technology captures real-time, site-specific weather data. Algorithms produce advanced forecasts for solar and wind output.

ADVANCED FORECASTING OF VARIABLE RENEWABLE POWER GENERATION

Improved weather forecasts allow accurate estimates of the amounts of solar and wind electricity likely to be available in specific time frames.

ABOUT THIS BRIEF

This brief forms part of the IRENA project “Innovation landscape for a renewable-powered future”, which maps the relevant innovations, identifies the synergies and formulates solutions for integrating high shares of variable renewable energy (VRE) into power systems.

The synthesis report, “*Innovation landscape for a renewable-powered future: Solutions to integrate variable renewables*” (IRENA, 2019a), illustrates the need for synergies between different

innovations to create actual solutions. Solutions to drive the uptake of solar and wind power span four broad dimensions of innovation: enabling technologies, business models, market design and system operation.

Along with the synthesis report, the project includes a series of briefs, each covering one of 30 key innovations identified across those four dimensions. The 30 innovations are listed in the figure below.

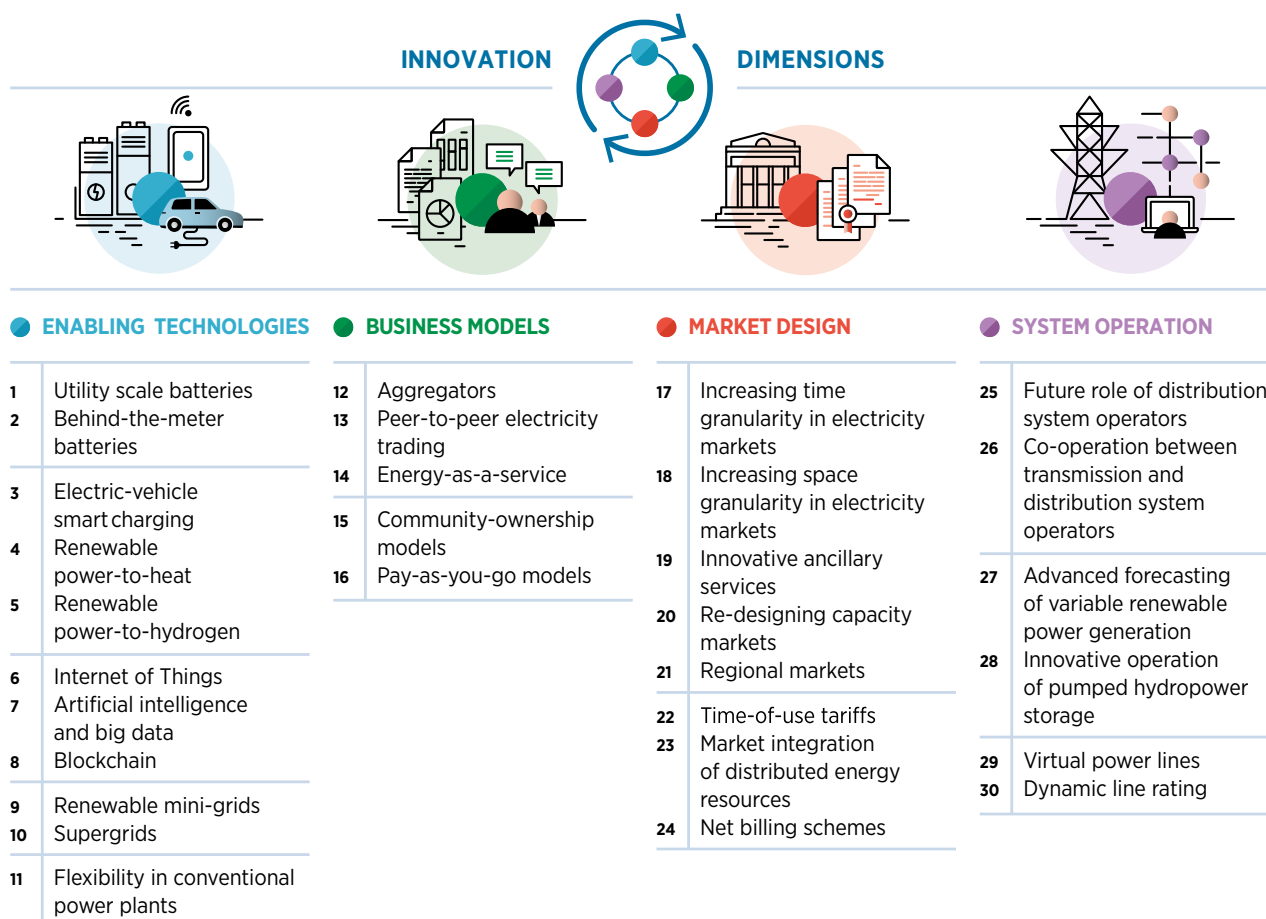

This brief provides an overview of the concept of advanced weather forecasting and its importance for VRE integration into power systems. Emphasis is placed on the contribution of both short- and long-term weather forecasting for renewable generators and power system operators. Key enablers required for its development and implementation are presented, together with examples of ongoing initiatives.

The brief is structured as follows:

- I [Description](#)
 - II [Contribution to power sector transformation](#)
 - III [Key factors to enable deployment](#)
 - IV [Current status and examples of ongoing initiatives](#)
 - V [Implementation requirements: Checklist](#)
-



I. DESCRIPTION

Accurate weather forecasting is crucial for integrating wind and solar power generating resources into the grid, especially at high penetration levels. It is a crucial, cost-effective tool available to both renewable energy generators and system operators (NREL, 2016).

For weather-dependent renewable generators, like solar and wind power plants, the most critical scheduling input comes from weather forecasting data. A power generation forecast is a combination of plant availability and weather forecasts for the location, as illustrated in Figure 1.

Figure 1 Weather and power generation forecast

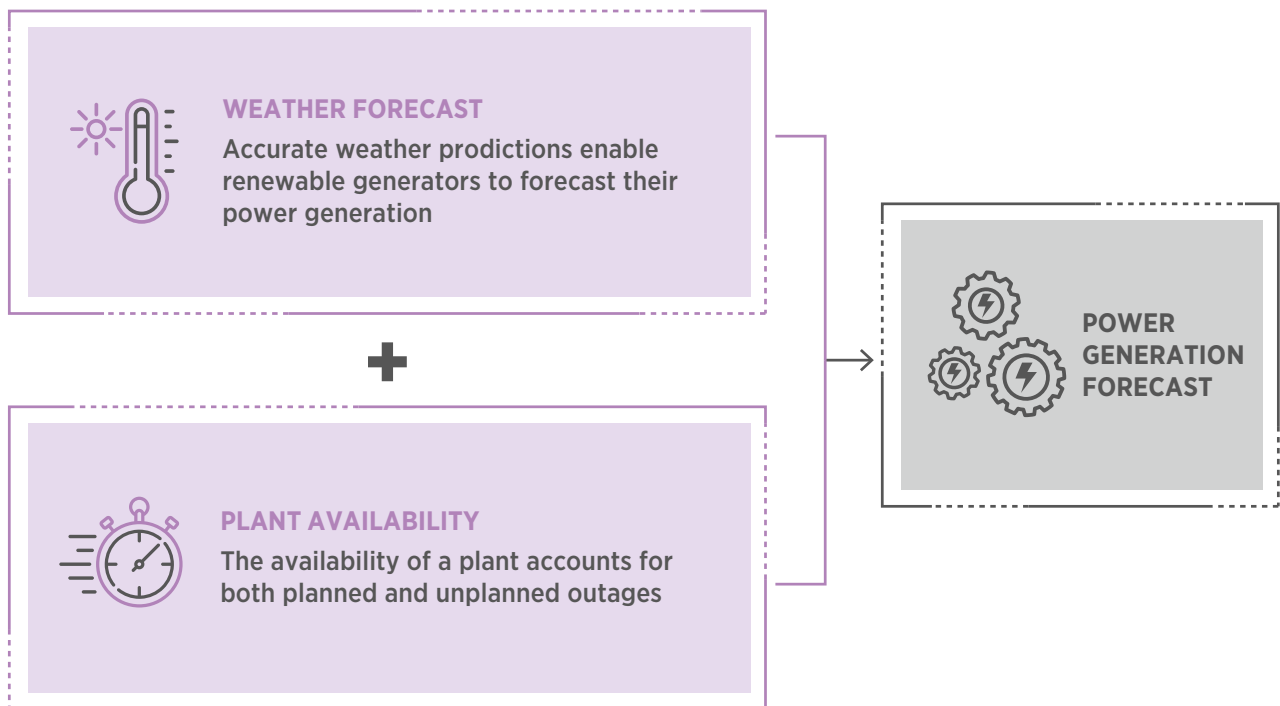

Advanced weather forecasting methods take advantage of advances in digital technologies, such as artificial intelligence (AI) and big data, to analyse live and historical weather data and make predictions. In fact, advanced weather forecasting is one of the main applications of AI in facilitating and improving VRE integration (for more information see *Innovation landscape brief: Artificial Intelligence and Big Data* [IRENA, 2019b]). Driven by an increase in computing power and improvement in algorithms, power generation forecasts have become more accurate. In a similar vein, thanks to the increasing use of AI fuelled by big data, time granularity for short-term predictions has increased as well. These factors can greatly contribute to the integration of renewable power into the grid (Bullis, 2014).

Improving VRE generation forecasts on short-term and long-term timescales engenders a diverse set of benefits for various stakeholders in the power sector. At short timescales, accurate VRE generation forecasting can help asset owners and market players to better bid in the electricity markets, where applicable. Bids based on more accurate forecasts would reduce the risk of incurring penalties for imbalances (*i.e.* for not complying with the generation offered in the bid). For power system operators, accurate short-term VRE generation forecasting can improve unit commitment (operation scheduling of the generating units) and operational planning, increase dispatch efficiency, reduce reliability issues and, therefore, minimise the amount of operating reserves needed in the system.

Over longer timescales (*e.g.* over days or seasons), improved VRE generation forecasting based on accurate weather forecasting brings significant benefits to system operators, especially when planning for extreme weather events. By contributing to the allocation of appropriate balancing reserves, long-term weather forecasting assists in ensuring safe and reliable system operations. It can also help in better planning the long-term expansion of the system, both generation and network transmission capacity, needed to efficiently meet future demand.

Every energy forecast invariably starts with numerical weather prediction (NWP) models, which are the accepted baseline predictions being tuned and run by large and mostly government-funded organisations. NWP methods take weather data, such as temperature, pressure, humidity, as inputs to simulate weather conditions in the future using physical and mathematical laws.

These simulated weather predictions can then be converted to corresponding energy production from wind and solar resources. NWPs are normally used for 15-days-ahead forecasting. However, these models are not accurate over short timescales (less than a few hours). Statistical approaches are also commonly used and are based purely on historical learnings. Solar irradiation forecasts also employ sky imagers (digital cameras that produce high-quality sky images) and satellite imaging (data from networks of geostationary satellites) to track and predict cloud formations at different timescales. Hybrid models use two or more techniques in conjunction to minimise the forecasting error. These hybrid methods have produced the best forecasting results when compared with individual statistical and machine learning techniques for all types of time horizon (Akhter *et al.*, 2019).

Compared with large-scale dispatchable plants, forecasts for distributed solar photovoltaic (PV) generation are more difficult to produce because of the relatively small size and large number of solar PV sites. Such forecasts are most accurate when near-real-time power generation data and detailed static data (*e.g.* location, hardware information, panel orientation) are available for all connected systems (NREL, 2016).

For example, 11 Renewable Energy Management Centres (REMCs) are being set up in India. The REMCs are equipped with AI-based renewable energy forecasting and scheduling tools at the regional level and provide greater visualisation and enhanced situational awareness to the grid operators. In total, 55 gigawatts (GW) of renewable power (solar and wind) is being monitored through the 11 REMCs (Asian Power, 2020). In Germany, the power generation forecasts for transmission system operators (TSOs) and distribution system operators (DSOs) are calibrated and evaluated against estimations of the solar power production on a postal code level. Forecasts of aggregated distributed solar PV production are developed and validated by upscaling the output from a subset of representative solar PV sites. The process is similar in California, where information about all solar PV systems in the state is recorded and then combined with high-resolution solar irradiance values and weather predictions to forecast power output for the entire state. This bottom-up approach is employed by the California Independent System Operator (CAISO) to predict the total contribution of behind-the-meter solar plants to its grid.

Table 1 lists the methods used for power generation forecasting at different time horizons, as well as the key applications of these forecasts in the power sector. The forecasting accuracy decreases with the increase of forecast time

horizon, even for the same forecasting technique. Thus, the selection of a proper time horizon before designing a forecasting model is key to maintaining the accuracy of forecasting at an acceptable level (Akhter *et al.*, 2019).

Table 1 Generation forecast methods and applications

	Time Horizon	Methods	Key Applications
Power Generation Forecast	5–60 min ahead of real time	Statistical ^a , persistence ^b	Regulation, real-time dispatch, trading, market clearing
	1–6 hours ahead of real time	Blend of statistical and NWP models	Scheduling, load following, congestion management
	Day(s) ahead of real time	NWP with corrections for systematic biases ^c	Scheduling, reserve requirement, trading, congestion management
	Week(s), seasonal, 1 year or more ahead of real time	Climatological forecasts, NWP	Resource investment planning (generation, network), contingency analysis, maintenance planning, operation management

Source: Based on NREL (2016).

Note: min = minutes; NWP = numerical weather prediction.

^aUse historic and real-time generation data to provide statistical corrections to predictions of the NWP models.

^bSimple statistical methods that assume that the current generation will remain unchanged in the near future. They are used as benchmarks to evaluate other advanced forecasting models.

^cErrors inherent in the measurement process.

Very short-term forecasting (from seconds to 1 hour) is useful for real-time electricity dispatch, optimal reserves, and smoothing power production of solar and wind. Short-term forecasting (from 1 hour to 24 hours) is useful to increase the stability of the grid. Medium-term forecasting (one week to one month) maintains the power system planning and maintenance schedule by predicting the available electric power in the near future.

Long-term forecasting (one month to one year) helps transmission and distribution authorities in electricity generation planning, in addition to energy bidding and security operations (Akhter *et al.*, 2019).

Complex modelling is required to account for all the variables that affect local weather. Figure 2 illustrates, in a simplified way, the data needed and the methodology applied for VRE power plants' generation forecasts.

Figure 2 From weather to power generation forecast

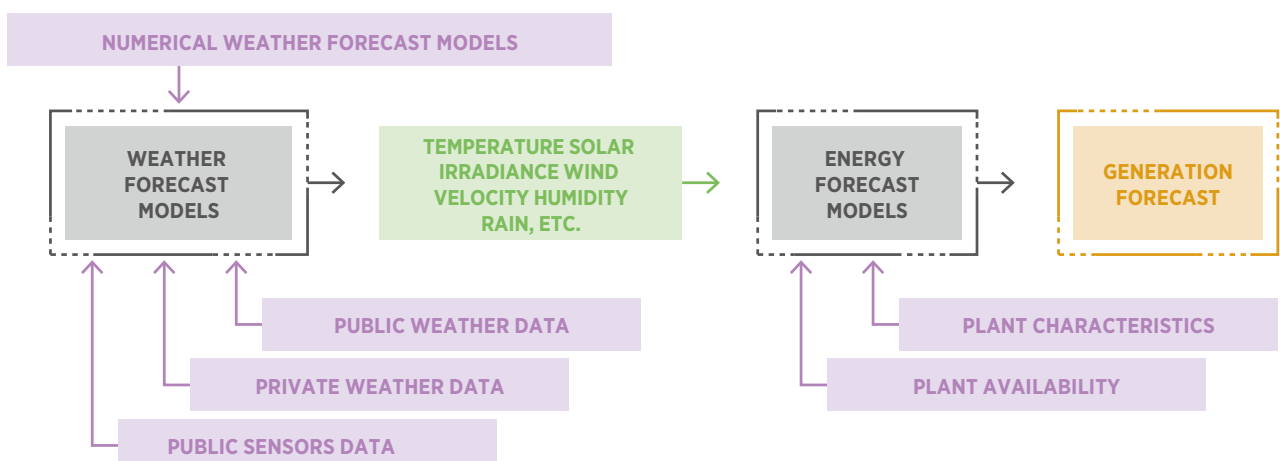

II. CONTRIBUTION TO POWER SECTOR TRANSFORMATION

Accurate weather forecasts and very short-term to long-term forecasting are key for effectively integrating VRE generation into the grid and bring valuable contributions for both renewable generators and system operators. Figure 3 summarises the benefits of short-term forecasting (defined here as minutes to one day ahead) and long-term forecasting (weeks to one year ahead).

System operators usually use centralised forecasting of renewable generation, widely considered a best-practice approach for a cost-effective dispatch.

Centralised forecasts provide systemwide forecasts for all VRE generators within a balancing area. Decentralised forecasts, administered by individual VRE asset operators, provide plant-level information to help inform system operators of potential transmission congestion due to a single plant’s output, as well as help position the plant’s bids in the forward or short-term markets (NREL, 2016). System operators can also benefit from decentralised forecasting by aggregating these data and using them for both short- and long-term operational procedures.

Figure 3 Benefits of weather forecasting to system operators and renewable generators

 BENEFITS OF WEATHER FORECASTING	CENTRALISED FORECASTING	DECENTRALISED FORECASTING
	For system operators	For renewable generators
Short-term forecasting	Improved network management and system balancing	Advantages for intraday and day-ahead electricity market trading
Long-term forecasting	Reserve planning and operation management	Efficient placement of renewable plants
	Planning for extreme weather events	

Contributions of short-term weather forecasting

Improved network management and system balancing

Short-term centralised forecasting is useful for applications related to system operations, such as real-time dispatch, market clearing and load following. Furthermore, accurate weather forecasting can also provide advantages in short-term electricity trading and system balancing. This leads to improved grid reliability and enables the efficient use of renewable energy resources.

Better weather forecasting using AI supercomputers that synthesise data from various sources, including historical weather data, real-time measurement of local weather conditions, satellites and sensors, is expected to lead to more accurate estimations of generation ramping requirements. More accurate estimations will be useful in improving grid reliability.

Day-ahead forecasts provide hourly power values used in the scheduling process to help avoid costs and inefficiencies due to unnecessary starts and stops of thermal generators. Intraday forecasts typically provide power values with frequent time steps (*i.e.*, every 10 minutes) up to a few hours ahead of real time. They are used in real-time dispatch and market-clearing decisions.

VRE generation forecasts can be, for example, integrated with load forecasting to produce net load forecasts, which improve the visibility of demand-side variations. VRE forecasts can be also integrated by system operators into a power flow module, which is a part of energy management systems, to detect voltage and congestion problems with a certain probability threshold.

Advantages for intraday and day-ahead electricity market trading

Short-term decentralised forecasts engender benefits for generators, especially if there is a functioning electricity market in place, and help renewable generators define their bidding strategies.

Accurate weather forecasts can enable renewable power generators to better estimate the generation and bid accordingly in intraday or day-ahead markets, reducing penalties imposed for deviations between actual and scheduled power generation. By using a more advanced forecasting solution with NWP models, renewable energy forecasts can be predicted closer to actual generation time. Statistical methods using AI models consider project-specific data along with nearby weather conditions for more accurate short-term forecasts. System operators in the United States, such as the Midcontinent Independent System Operator and Electric Reliability Council of Texas, combine short-term dispatch with very short-term forecasts (within 10 minutes of the actual flow of power), which allows wind power plants to be fully integrated into real-time intraday markets (Orwig *et al.*, 2015).

Contributions of long-term weather forecasting

Reserve planning and operation management

Long-term weather forecasts are valuable for system operators in applications such as reserve planning and operation management. Such forecasts may further assist generators and system operators in investment planning for, respectively, power plant construction and system expansion.

Planning for extreme weather events

Long-term weather forecasts can be used by system operators to predict extreme weather events and better plan and prepare for such occasions. For instance, the North Atlantic Oscillations, which are seasonal weather phenomena over the North Atlantic and Europe caused by pressure differentials, can cause as much as a 1020% variation in wind and solar generation (Jerez *et al.*, 2013). Long-term weather forecasts for such weather events can thus improve the resilience of the system, helping system operators in planning for alternative resources to ensure the security of supply.

Efficient placement of renewable plants

Long-term decentralised weather forecasts can help in the generation expansion of the system by identifying the best locations for the construction of new renewable power plants. For example, turbine placement in the wind industry is an important parameter affecting power generation. Major factors for appropriate turbine placement include wind speed, wind turbulence, wind direction, space and ecological considerations. Solar irradiation, also location specific, is crucial for solar PV projects.

Other important parameters are the zenith angle and the orientation of the PV panel. Advanced weather forecasting tools can be used for the identification of optimal sites for wind turbine and solar PV installations to improve generation outputs and reduce maintenance costs. Supercomputers can be used to analyse petabytes of structured and unstructured data – such as weather reports, tidal phases, geospatial and sensor data, satellite images, deforestation maps, and weather modelling research – to identify the optimal location of wind turbines (IBM, 2011).

Potential impact on power sector transformation

Several studies have explored the impact and implications of advanced forecasting for utilities, system operators and VRE generators:

- The impact of improvement in solar power forecasting was analysed in one study by evaluating the operations of the entire power system for four scenarios that represented four forecast improvement levels: 25%, 50%, 75% and 100% (perfect forecast). **The study showed that electricity generation from conventional sources (gas and oil generators) decreases with solar power forecasting improvement** (Martinez-Anido *et al.*, 2016).

Coal, gas combined-cycle, and gas and oil steam turbine generators are committed in the day-ahead run, while gas and oil turbines and internal combustion generators are committed in the real-time run. Table 2 shows, for different solar penetration levels, the impact of forecast improvement on the overall system generation mix. **Day-ahead operation can be better planned, and faster generators committed in real time can be used less, when solar power uncertainty decreases.**

Table 2 Impact of solar power forecasting improvement on power generation

Solar Penetration (%)	4.5				9.0				13.5				18.0			
	25	50	75	100	25	50	75	100	25	50	75	100	25	50	75	100
Coal (%change)	0.0	0.0	0.0	0.1	0.1	0.2	0.2	0.3	0.1	0.3	0.4	0.5	0.2	0.4	0.4	0.4
Gas CC (%change)	0.0	0.2	0.1	0.1	0.1	0.1	0.2	0.3	0.3	0.7	0.9	1.1	0.5	0.9	1.4	1.8
Gas and Oil ST (%change)	-0.1	-1.4	-0.8	-0.8	0.6	1.2	0.5	0.0	-1.3	-2.8	-3.9	-4.8	-1.9	-3.5	-5.3	-5.5
Gas and Oil GT & IC (%change)	-0.8	-1.8	-1.9	-1.7	-4.5	-7.5	-8.6	-10.2	-3.9	-8.8	-12.1	-13.7	-5.1	-10.5	-14.3	-17.5

Source: Martinez-Anido *et al.* (2016).

Note: CC = combined-cycle; ST = steam turbine ; GT = gas and oil turbine; IC = internal combustion;

The study shows also a **considerable decrease in solar power curtailment** with the improved

forecast. The results of the study are shown in Table 3.

Table 3 Impact of solar power forecasting improvement on solar power curtailment

Impact (% change)	Solar penetration (%)		
Forecast Improvement (%)	9.0	13.5	18.0
25	-2.3	-1.2	-1.5
50	-4.0	-2.3	-2.7
75	-5.2	-3.5	-3.5
100	-5.4	-4.2	-3.8

Source: Martinez-Anido *et al.* (2016).

The same study found that the **impact of solar forecasting improvements** on solar curtailment and electricity generation, including ramping,

starts and shutdowns on fossil fuel generators, results in **lower operational costs for the system**, as shown in Table 4.

Table 4 Cost savings from solar power forecasting improvement per unit of solar power generation

Forecasting improvement cost savings (\$/MWh)	Solar penetration (%)			
Forecast Improvement (%)	4.5	9.0	13.5	18.0
25	0.11	0.33	0.39	0.50
50	0.29	0.62	0.77	0.95
75	0.30	0.74	1.03	1.25
100	0.32	0.82	1.13	1.42

Source: Martinez-Anido *et al.* (2016).

Note: MWh = megawatt-hours.

- National Grid, the TSO in the United Kingdom, is using AI and machine learning to help predict solar and wind generation. National Grid announced that its **new AI prediction models have improved solar forecasting by one-third**. The new system combines

information, including temperature data, solar irradiation data, and historic weather data, to reach an output generation figure, which is then tested against 80 weather forecasts to give an energy generation forecast (Cuff, 2019).

- A study by the **California Energy Commission** evaluates the impact of improvement in solar and load forecasting on system operation in California (California Energy Commission, 2019). Solar forecasting includes forecasting for individual utility-scale resources and aggregated behind-the-meter resources, which total nearly 6 GW. Possible improvements to the solar forecasts include incorporating age-related degradation; improving inverter modelling, incorporating ever-changing amounts of solar capacity; and handling real-world performance issues, such as soiling, system outages and shading.

However, the impact of behind-the-meter solar PV is not considered in forecasting loads in California. The study extended the existing load forecasting models to capture the influence of behind-the-meter solar PV and predict an increasingly volatile load. The results showed that **improvements in solar and net load forecasting methods can provide positive financial impacts in the scheduling and procurement of electricity** in the wholesale electric market

within California. The results indicate that potential **savings of approximately USD 2 million per year** can be made, based on an average annual CAISO load of 26 GW and an average regulation cost of USD 9 per megawatt-hour. In addition to financial savings from operation, emission savings should result from the reduction in the need for spinning reserves (California Energy Commission, 2019).

- A study conducted for the California Independent System Operator (CASIO) shows that **improved short-term wind forecasting** in the CAISO market can **result in annual total cost savings¹ between USD 5 million and USD 146 million**, depending on the scenario, as shown in Table 5 (Hodge *et al.*, 2015). In the low wind scenario, available wind capacity amounts to 7 299 megawatts (MW), and in the high wind scenario, 11 109 MW of available wind capacity is expected. The time-based variability in the wind speed determines the instantaneous penetration level and the degree to which the forecasting accuracy influences the actual dispatch of generation.

Table 5 Total cost savings from improved wind power forecasting

Wind Scenario	Forecast improvement	Annual Savings (USD)
Low	10% uniform improvement	5 050 000
High		25 100 000
Low	25% uniform improvement	14 800 000
High		62 900 000
Low	50% uniform improvement	34 700 000
High		146 000 000

Source: Based on Hodge, *et al.* (2015).

¹ Capacity reserve, frequency regulation reserve and production cost savings.

III. KEY FACTORS TO ENABLE DEPLOYMENT

A regulatory environment incentivising accurate VRE power generation forecasting

To enhance the operation of a power system with significant VRE shares, the regulatory and electricity market arrangements need to increase time granularity; in other words, the dispatch and scheduling time interval, the pricing of market time units, financial settlement periods, and the time span between gate closure and the real-time delivery of power should be reduced (for more information see *Innovation landscape brief: Increasing time granularity in electricity markets* [IRENA, 2019c]).

In this way, advanced weather forecasting methods, by delivering granular results and data closer to real time, become very important for VRE power generation. For instance, the Electric Reliability Council of Texas has reduced the dispatch time intervals from 15 minutes to 5 minutes, allowing updates in generation schedules until 10 minutes before the actual power dispatch. This change in rule has incentivised the use of better weather and generation forecasting methods and has resulted in reduction of wind curtailment due to better accuracy in generation forecasts 5 minutes before the actual generation, compared with the previous 15 minutes (Bridge to India, 2017).

Simultaneously, VRE generators and system operators must be incentivised to produce accurate generation forecasts at different timescales (*i.e.* week ahead, day ahead, intraday), providing the same time granularity as that used in the electricity markets. Accurate forecasts engender different benefits to generators and system operators. For this reason, two types of forecast are needed: centralised forecasting for system operators to maintain overall reliability;

and decentralised forecasting for VRE generators, enabling them to revise their schedules and dispatch instructions. System operators can also benefit from the decentralised forecasting of VRE generators if communication between these stakeholders is established and automatised. Penalties for significant deviations in generation forecasts, compared with actual generation, can be implemented to incentivise improving the accuracy of decentralised forecasts.

Open source systems for weather data collection and sharing

Advances in digital technologies and data science, such as AI and big data - including predictive analytics and machine learning algorithms - can improve weather forecasting. However, these algorithms require large numbers of datasets to make accurate predictions. Therefore, open sourcing weather data collected by the weather monitoring stations of VRE generators, national meteorological institutes, and information and communication technology developers can foster rapid advances in data analytical techniques and consequently in weather forecasting.

For weather data collection, a network of weather stations at national or regional level can be deployed to collect and store long-term meteorological data, which can be used to characterise renewable energy resources. The Institute for Environmental Research and Sustainable Development, for example, operates such a network of automated weather stations across Greece. As of December 2016, 335 weather stations were operational and providing real-time data at 10-minute time intervals. These weather data are used by power system operators and private VRE generators, along with other industries, to plan and forecast both the load and the generation from various power generating resources.

For the last 30 years, the Joint Research Centre has produced a dataset (known as EMHIREs) of wind energy production by the hour at the national, regional and local levels across the European Union; these data can be fed into advanced weather forecasting models for more accurate wind power generation forecasts to help policy makers devise better energy frameworks (European Commission, 2016).

At large power plants, meter data are typically available in near real time, and site metadata are generally known. For smaller distribution connected plants, dedicated meter data are usually available and recorded but are often not telemetered in real time, nor systematically used for system operation procedures.

Advanced meteorological devices

Other weather forecasting tools and models that are being experimented with include the use of advanced cloud-imaging technology; sky-facing cameras to track cloud movements; and sensors

installed on turbines to monitor wind speed, temperature and direction. Using such advanced meteorological devices, which are connected to the Internet, may help in gathering information of real-time, site-specific weather conditions (for more information on Internet-connected devices, see *Innovation Landscape Brief: Internet of Things* [IRENA, 2019d]).

However, the impact of these instruments is still being investigated, and the technologies remain relatively expensive. Advanced ultrasonic sensors using ultrasound are being trialled to measure horizontal wind speed and direction. Sky cameras are also being tested to study cloud coverage, ultraviolet index, cloud movement, cloud heights, sky polarisation and wind speed at cloud heights. Automated weather stations attached to solar panels or wind turbines to report real-time information are also being developed. These weather stations contain data loggers and meteorological sensors that collect and save weather data for later applications.

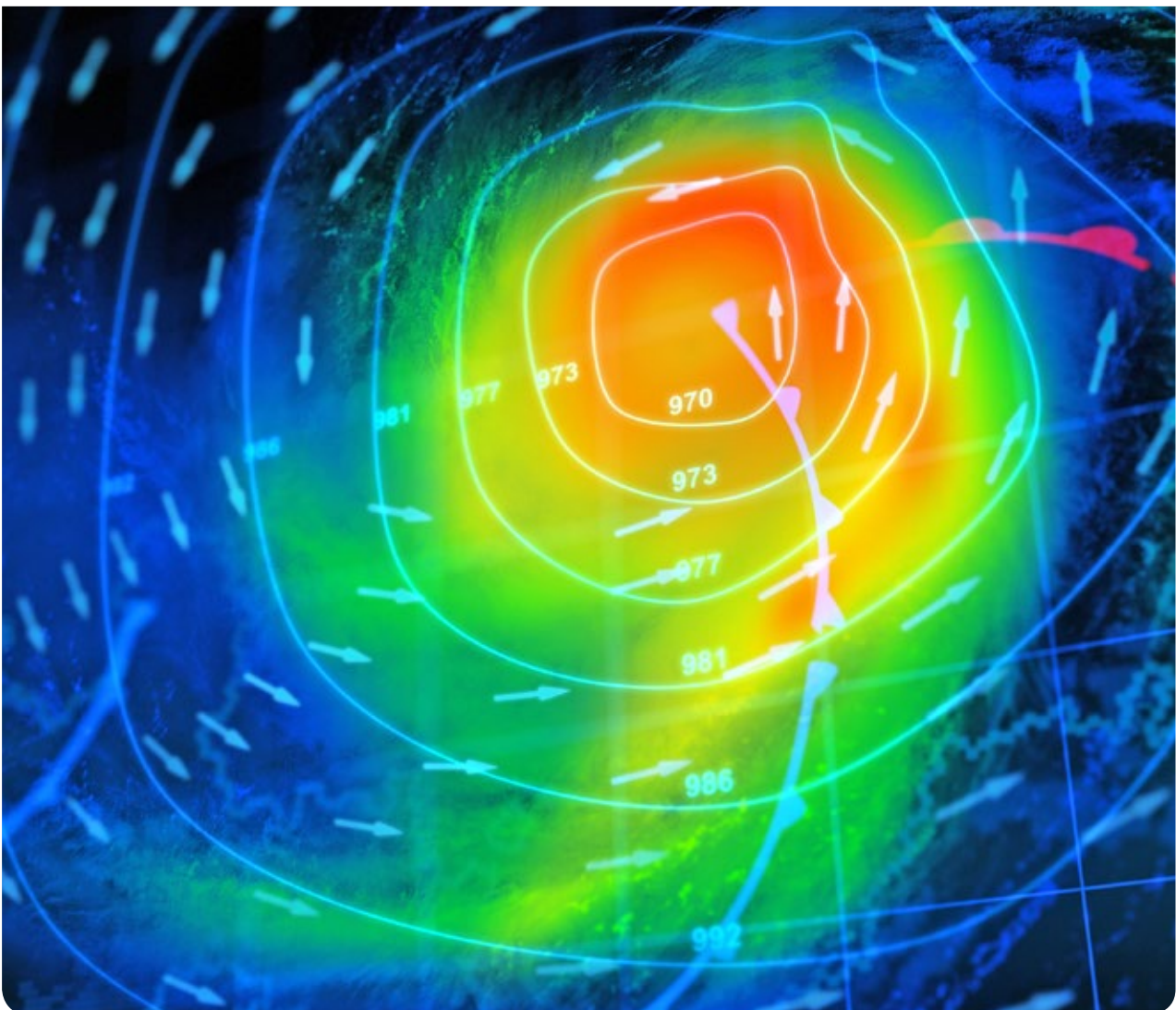

IV. CURRENT CONTEXT AND ONGOING INITIATIVES

Short-term VRE generation forecasting solutions in Australia

The Australian Renewable Energy Agency (ARENA) awarded funding of some USD 5.6 million (AUD 9.4 million) to 11 projects to trial short-term forecasting at large-scale wind and solar farms across Australia. The trial covers at least 45% of the National Electricity Market's registered wind and solar capacity, which collectively provides a total of 3.5 GW of renewable electricity generation (ARENA, 2019).

The funding is part of ARENA's Advancing Renewables Program, and part of the study will focus on improving the Australian Wind Energy Forecasting System's 5-minute forecast. This solution will allow ARENA to more accurately forecast wind generation, reduce wind generators' dispatch uncertainty and improve system stability by balancing the energy supply and demand in the market.

The solution involves applying advanced data science techniques, including deep learning, to deliver greater accuracy in energy forecasts, both for specific sites and technologies and for the system as a whole.

These are applied to high-resolution wind turbine data from the supervisory control and data acquisition system, granular short-term hyperlocal weather forecasts and meteorological data. The solution will couple physical and statistical models with an industry-best 1 square kilometre (km²) precision, compared with traditional global weather forecasts, which operate at coarser temporal resolution and 16 km² spatial resolution (Utopus Insights, 2019).

Sun4Cast Solar Generation Forecasting System in United States

The Sun4Cast solar generation forecasting system combines various forecasting technologies, covering a variety of temporal and spatial scales, to predict local solar irradiance. Forecasts from multiple NWP models are combined via the Dynamic Integrated foreCast System², used for deriving forecasts beyond 6 hours, and the observation-based "nowcasting" technologies³, used for short-term forecasts ranging from 0 to 6 hours. These technologies are integrated to derive irradiance forecasts. These irradiance forecasts are converted into expected electricity generation values, which are then provided to industry partners for real-time decision-making (Haupt *et al.*, 2018).

² *The Dynamic Integrated foreCast System uses meteorological data (observations, numerical model output, statistical data, climate data, etc.) and produces tuned meteorological forecasts at user-defined forecast sites and lead times (NCAR Research Applications Laboratory, 2017).*

³ *Nowcasting combines the current state of the atmosphere with a short-term forecast of how the atmosphere will evolve over the next several hours (Mass, 2012).*

EWeLiNE, ORKA, ORKA2 and Gridcast projects improving VRE generation forecasts in Germany

Since 2012, the Deutscher Wetterdienst (German Meteorological Service) has been working on optimising its weather forecasts for renewable energy applications within the research projects EWeLiNE and ORKA, funded by the Federal Ministry for Economic Affairs and Energy. On the basis of the findings of the ORKA project in December 2015, this successful co-operation was continued in a new project, ORKA2, implemented in 2016, followed by a new project called Gridcast in 2017. In these projects, the German Meteorological Service and the Fraunhofer Institute for Wind Energy and Energy System Technology worked with the three German TSOs (Amprion GmbH, TenneT TSO GmbH and 50Hertz Transmission GmbH), one manufacturer of wind energy systems and two DSOs.

Their goal was to improve the weather and power forecasts for wind turbines and solar PV plants and to develop new forecast products focusing specifically on grid stability. These projects allowed them to use real-time data from solar panels and wind turbines around Germany and to feed those data into an algorithm that uses machine learning to calculate the renewable energy output. After testing, the researchers concluded that the newly developed forecast models have better forecast accuracy, with higher temporal and spatial resolution, than conventional models.

The new models also have better weather warnings, which are adapted to grid operation, especially when faced with extreme weather conditions, such as strong winds. Therefore, solar radiation data are calculated every 15 minutes, enabling the system operators to better estimate if they need additional resources to maintain grid stability. As a next step, the Gridcast project aims to integrate satellite images for solar forecasts in addition to the existing weather forecast data, thereby helping system operators better manage the system with high shares of VRE (IRENA, 2020).

Hybrid Renewable Energy Forecasting for advanced wind forecasting in China

The Hybrid Renewable Energy Forecasting (HyRef) project installed at a hybrid 670 MW solar and wind generation unit, created by IBM for the Chinese State Grid's Jibe Electric Power Company Limited, is using advanced data analytics to improve the forecasting of wind power output. By using advanced tools for weather modelling, cloud-imaging technology and sky-facing cameras, paired with sensors on the wind turbine, HyRef can forecast the power output months ahead, but also up to 15 minutes before actual generation. As a consequence of using these technologies, wind curtailment has been reduced by 10%, which is the equivalent of supplying some additional 14 000 homes with electricity (Cochran *et al.*, 2013).



V. IMPLEMENTATION REQUIREMENTS: CHECKLIST

TECHNICAL REQUIREMENTS



Hardware:

- Smart meters to monitor real-time power production
- Weather sensors to continuously monitor changes in weather
- Wind turbine sensors to monitor the functioning of wind turbines
- Regional/national network of weather stations to continuously monitor weather patterns
- Sky imagers
- Satellite data

Software:

- Advanced weather forecasting tools based on a combination of input data (historical data, real-time data, etc.)
- Advanced power generation forecasting tools based on weather forecasting and power plant parameters (e.g. availability)
- Data analytics software (i.e. AI software, such as machine learning platforms)

Communication protocols:

- Common interoperable protocol co-ordination between VRE developers, asset owners, system operators (and consumers)

REGULATORY REQUIREMENTS



Retail market:

- Establish common open databases of weather data that can be accessed for free or at a small cost, which is necessary to bring down costs for smaller asset owners; these databases can have a large impact on the grid when aggregated
- Enable visibility of generation from distributed energy resources, like small-scale wind and solar PV generators (typically sub-megawatt)

Transmission and distribution system operators:

- Allow DSOs to monitor power generation data from distributed solar and small-scale wind projects
- Allow TSOs to integrate real-time VRE forecasts into the dispatch schedule
- Grid codes that cover data requirements for efficient VRE power generation forecasting

Wholesale market:

- Reward accuracy and penalise large deviations in scheduling and dispatch from market participants, where markets are in place

STAKEHOLDER ROLES AND RESPONSIBILITIES



Policy makers:

- Support the development of advanced forecasting tools for weather and VRE power generation
- Deploy mechanisms to record weather data at various locations to accurately forecast VRE power generation

System operators:

- Enable transmission and/or system operators to play the role of “data custodians”
- In liberalised markets, allow authorised third-party vendors to use data for developing new forecasting tools

VRE generators:

- Equip VRE plants with supervisory control and data acquisition systems, sensors and software for accurate power generation forecasts
- Make use of the most advanced weather forecasting technology for optimised VRE generation (to participate in markets or to inform system operators of the forecasted generation output)

Meteorological and research institutes:

- Collaborate with the renewable power industry, including system operators, to refine the weather forecasting tools to improve VRE integration into the power system

ABBREVIATIONS

AI	artificial intelligence	km²	square kilometre
ARENA	Australian Renewable Energy Agency	MW	megawatt
CAISO	California Independent System Operator	NWP	numerical weather prediction
DSO	distribution system operator	PV	photovoltaic
GW	gigawatt	REMC	Renewable Energy Management Centre
HyRef	Hybrid Renewable Energy Forecasting	TSO	transmission system operator
		VRE	variable renewable energy

BIBLIOGRAPHY

- Akhter, M.N. et al.** (2019), “Review on forecasting of photovoltaic power generation based on machine learning and metaheuristic techniques”, *IET Renewable Power Generation*, Vol. 13/7, Institution of Engineering and Technology, Stevenage, United Kingdom, pp. 1 009–1 023, <https://ieeexplore.ieee.org/document/8707118>.
- ARENA** (2019), “\$9 million funding to enhance short term forecasting of wind and solar farms”, Australian Renewable Energy Agency, <https://arena.gov.au/news/9-million-funding-to-enhance-short-term-forecasting-of-wind-and-solar-farms>.
- Asian Power** (2020), “India inaugurates 11 renewable energy management centres”, <https://asian-power.com/power-utility/news/india-inaugurates-11-renewable-energy-management-centres>.
- Bridge to India** (2017), “Southern region to lead India in grid integration of renewable energy – Bridge to India”, PV Tech, 26 May, www.pv-tech.org/guest-blog/southern-region-to-lead-india-in-grid-integration-of-renewable-energy-bridg.
- Bullis, K.** (2014), “Smart wind and solar power”, *MIT Technology Review*, May/June, www.technologyreview.com/s/526541/smart-wind-and-solar-power.
- California Energy Commission** (2019), *Improving Solar and Load Forecasts by Reducing Operational Uncertainty*, Energy Research and Development Division, San Diego, <https://ww2.energy.ca.gov/2019publications/CEC-500-2019-023/CEC-500-2019-023.pdf>.
- Cochran, J. et al.** (2013), *Market Evolution: Wholesale Electricity Market Design for 21st Century Power Systems*, National Renewable Energy Laboratory, Golden, Colorado, www.nrel.gov/docs/fy14osti/57477.pdf.
- Cuff, M.** (2019), “AI-powered weather forecasts are improving predictions for smart grids’ energy outputs”, GreenBiz, www.greenbiz.com/article/ai-powered-weather-forecasts-are-improving-predictions-smart-grids-energy-outputs.
- European Commission** (2016), “How much wind energy can be generated in your area? Check EMHIREs”, EU Science Hub, 23 November, <https://ec.europa.eu/jrc/en/news/how-much-wind-energy-can-be-generated-your-area-check-emhires>.
- Haupt, S.E. et al.** (2018), “Building the Sun4Cast system: Improvements in solar power forecasting”, *Bulletin of the American Meteorological Society*, Vol. 99, American Meteorological Society, Boston, pp. 121–136, <https://journals.ametsoc.org/doi/abs/10.1175/BAMS-D-16-0221.1>.

Hodge, B.-M. et al. (2015), *The Value of Improved Short-Term Wind Power Forecasting*, National Renewable Energy Laboratory, Golden, Colorado, www.nrel.gov/docs/fy15osti/63175.pdf.

IBM (2011), "Vestas Wind Systems turns to IBM big data analytics for smarter wind energy", IBM, 24 October, www-03.ibm.com/press/us/en/pressrelease/35737.wss.

IRENA (2020), *Innovative solutions for 100% renewable power in Sweden*, IRENA, Abu Dhabi, www.irena.org/publications/2020/Jan/Innovative-solutions-for-100-percent-renewable-power-in-Sweden.

IRENA (2019a), *Innovation landscape for a renewable-powered future: Solutions to integrate variable renewables*, International Renewable Energy Agency, Abu Dhabi, www.irena.org/publications/2019/Feb/Innovation-landscape-for-a-renewable-powered-future.

IRENA (2019b), *Innovation landscape brief: Artificial intelligence and big data*, International Renewable Energy Agency, Abu Dhabi, www.irena.org/publications/2019/Sep/Artificial-Intelligence-and-Big-Data.

IRENA (2019c), *Innovation landscape brief: Increasing time granularity in electricity markets*, International Renewable Energy Agency, Abu Dhabi, https://irena.org/-/media/Files/IRENA/Agency/Publication/2019/Feb/IRENA_Increasing_time_granularity_2019.pdf.

IRENA (2019d), *Innovation landscape brief: Internet of Things*, International Renewable Energy Agency, Abu Dhabi, www.irena.org/publications/2019/Sep/Internet-of-Things.

Jerez, S. et al. (2013), "The impact of the North Atlantic Oscillation on renewable energy resources in southwestern Europe", *Journal of Applied Meteorology and Climatology*, Vol. 52, American Meteorological Society, Boston, pp. 2 204–2 225, <https://journals.ametsoc.org/doi/full/10.1175/JAMC-D-12-0257.1>.

Martinez-Anido, C.B. et al. (2016), "The value of day-ahead solar power forecasting improvement," *Solar Energy*, Vol. 129, Elsevier, Amsterdam, pp. 192–203.

Mass, C. (2012), "Nowcasting: The promise of new technologies of communication, modeling, and observation", *Bulletin of the American Meteorological Society*, Vol. 93, American Meteorological Society, Boston, pp. 797–809, <https://journals.ametsoc.org/doi/abs/10.1175/BAMS-D-11-00153.1>.

NCAR Research Applications Laboratory (2017), "Dynamic integrated forecast (dicast®) system", <https://ral.ucar.edu/projects/dynamic-integrated-forecast-dicast%C2%AE-system>.

NREL (2016), *Forecasting wind and solar generation: improving system operations*, National Renewable Energy Laboratory, Golden, Colorado, www.greeningthegrid.org/resources/factsheets/copy_of_ForecastingWindandSolarGeneration.pdf.

Orwig, K.D. et al. (2015), "Recent trends in variable generation forecasting and its value to the power system", *IEEE Transactions on Sustainable Energy*, Vol. 6/3, pp. 924–933, <https://ieeexplore.ieee.org/document/6996049>.

Utopus Insights (2019), "Vestas and Utopus Insights to pilot energy forecasting solutions for renewable power plants in Australia", www.utopusinsights.com/australiapilot.

ADVANCED FORECASTING OF VARIABLE RENEWABLE POWER GENERATION INNOVATION LANDSCAPE BRIEF

© IRENA 2020

IRENA HEADQUARTERS

P.O. Box 236, Abu Dhabi
United Arab Emirates

www.irena.org

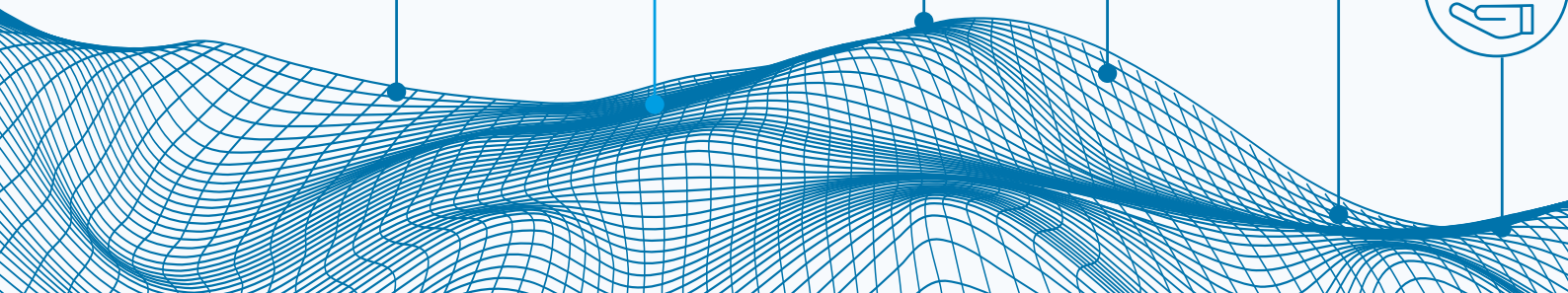
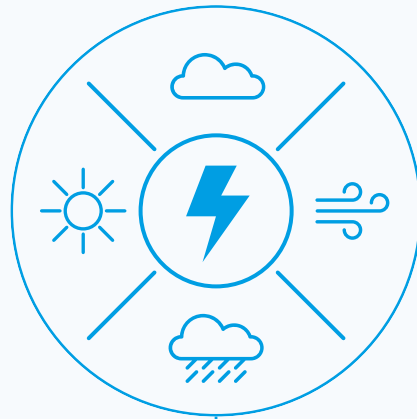

INNOVATIVE OPERATION OF PUMPED HYDROPOWER STORAGE

INNOVATION LANDSCAPE BRIEF

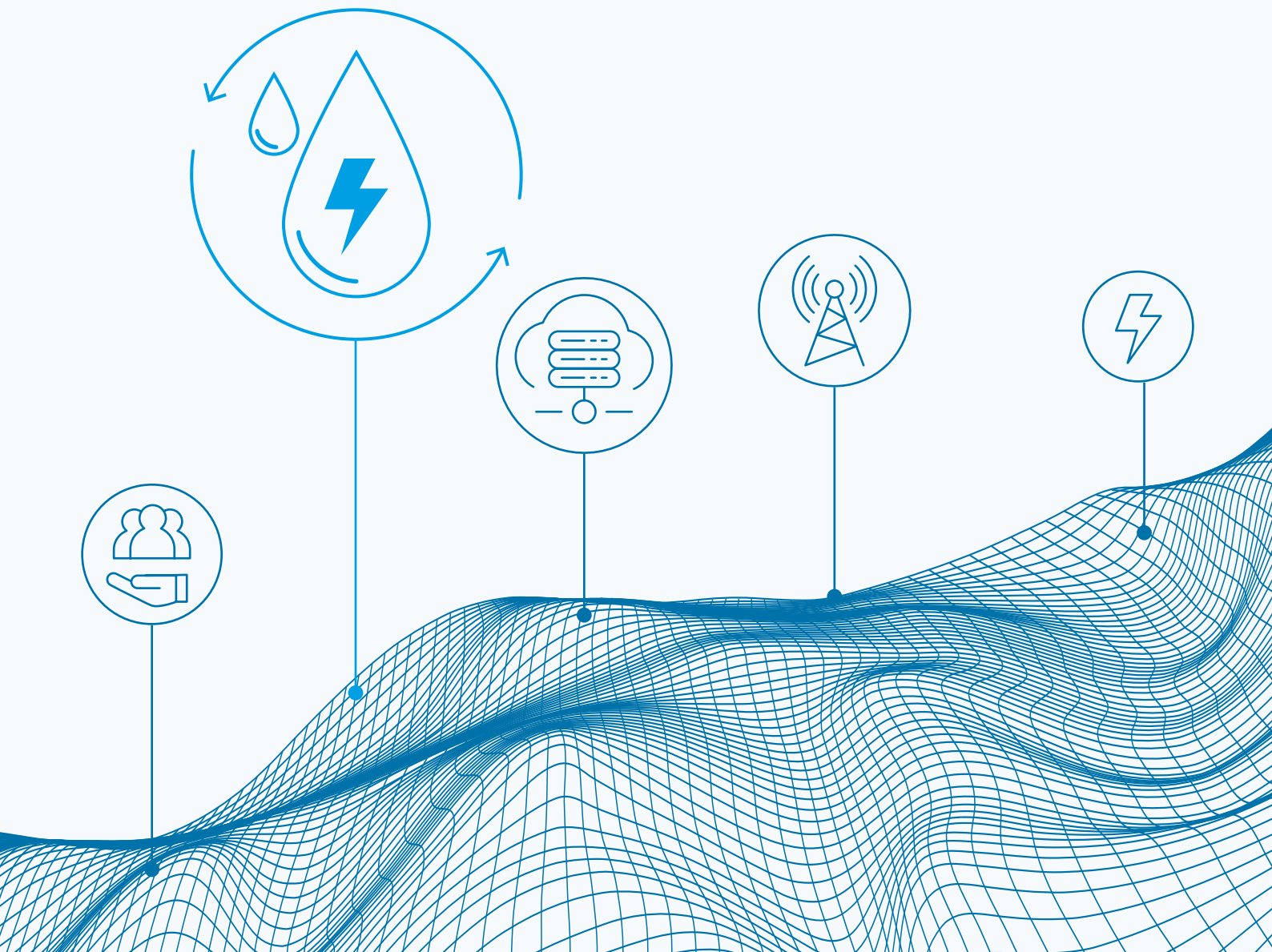

© IRENA 2020

Unless otherwise stated, material in this publication may be freely used, shared, copied, reproduced, printed and/or stored, provided that appropriate acknowledgement is given of IRENA as the source and copyright holder. Material in this publication that is attributed to third parties may be subject to separate terms of use and restrictions, and appropriate permissions from these third parties may need to be secured before any use of such material.

ISBN 978-92-9260-180-5

Citation: IRENA (2020), *Innovation landscape brief: Innovative operation of pumped hydropower storage*, International Renewable Energy Agency, Abu Dhabi.

ABOUT IRENA

The International Renewable Energy Agency (IRENA) is an intergovernmental organisation that supports countries in their transition to a sustainable energy future and serves as the principal platform for international co-operation, a centre of excellence, and a repository of policy, technology, resource and financial knowledge on renewable energy. IRENA promotes the widespread adoption and sustainable use of all forms of renewable energy, including bioenergy, geothermal, hydropower, ocean, solar and wind energy in the pursuit of sustainable development, energy access, energy security and low-carbon economic growth and prosperity. www.irena.org

ACKNOWLEDGEMENTS

This report was prepared by the Innovation team at IRENA's Innovation and Technology Centre (IITC) and was authored by Nadeem Goussous, Alessandra Salgado, Arina Anisie and Francisco Boshell.

Valuable review was provided by Mathis Rogner and Samuel Law (International Hydropower Association), Guido Federer (Swiss Federal Office of Energy), Rafael Kelman (PSR), Miguel Garagorri Miota and Marta Martinez Sanchez (Iberdrola), Candelaria Sánchez Galán (Gorona del Viento) and Hiroaki Yoshitake (Kyushu Electric Power), along with Elena Ocenic, Harold Anuta, Laura Casado and Paul Komor (IRENA).

DISCLAIMER

This publication and the material herein are provided "as is". All reasonable precautions have been taken by IRENA to verify the reliability of the material in this publication. However, neither IRENA nor any of its officials, agents, data or other third-party content providers provides a warranty of any kind, either expressed or implied, and they accept no responsibility or liability for any consequence of use of the publication or material herein.

The information contained herein does not necessarily represent the views of all Members of IRENA. The mention of specific companies or certain projects or products does not imply that they are endorsed or recommended by IRENA in preference to others of a similar nature that are not mentioned. The designations employed and the presentation of material herein do not imply the expression of any opinion on the part of IRENA concerning the legal status of any region, country, territory, city or area or of its authorities, or concerning the delimitation of frontiers or boundaries.

Photographs are from Shutterstock unless otherwise indicated.

This document does not represent the official position of IRENA on any particular topic. Rather, it is intended as a contribution to technical discussions on the promotion of renewable energy.

1 BENEFITS





Pumped hydropower storage (PHS) ranges from instantaneous operation to the scale of minutes and days, providing corresponding services to the whole power system.



PHS coupled with VRE

- Load shifting and reduction of variable renewable energy (VRE) curtailment
- Frequency regulation
- Fast and flexible ramping
- Black start
- Capacity firming

2 KEY ENABLING FACTORS

-  Regulatory framework incentivising flexible operation
-  Digitalisation of PHS systems
-  Retrofitting PHS facilities
-  Public-private research, development and demonstration (RD&D) projects

3 SNAPSHOT

- Installed PHS capacity reached 161 gigawatts (GW) by 2018
- PHS capacity is set to double by 2050
- A wind-hydropower hybrid project with PHS supported 100% renewable power generation for 24 days on El Hierro in Spain's Canary Islands in mid-2019
- Dinorwig power station in Wales, UK, (1.8 gigawatt generation capacity and 11 gigawatt-hours storage) is Europe's largest PHS system, sufficient to cover peak load.

STORAGE TO ENHANCE SOLAR AND WIND POWER

Different PHS configurations to optimise VRE integration:

Conventional PHS balancing systems with VRE



VRE plants with PHS as storage on site



VRE technologies integrated into PHS facilities



INNOVATIVE OPERATION OF PUMPED HYDROPOWER STORAGE

Pumped Hydropower Storage (PHS) serves as a giant water-based "battery", helping to manage the variability of solar and wind power

ABOUT THIS BRIEF

This brief forms part of the IRENA project “Innovation landscape for a renewable-powered future”, which maps the relevant innovations, identifies the synergies and formulates solutions for integrating high shares of variable renewable energy (VRE) into power systems.

The synthesis report, “*Innovation landscape for a renewable-powered future: Solutions to integrate variable renewables*” (IRENA, 2019a), illustrates the need for synergies between different

innovations to create actual solutions. Solutions to drive the uptake of solar and wind power span four broad dimensions of innovation: enabling technologies, business models, market design and system operation.

Along with the synthesis report, the project includes a series of briefs, each covering one of 30 key innovations identified across those four dimensions. The 30 innovations are listed in the figure below.

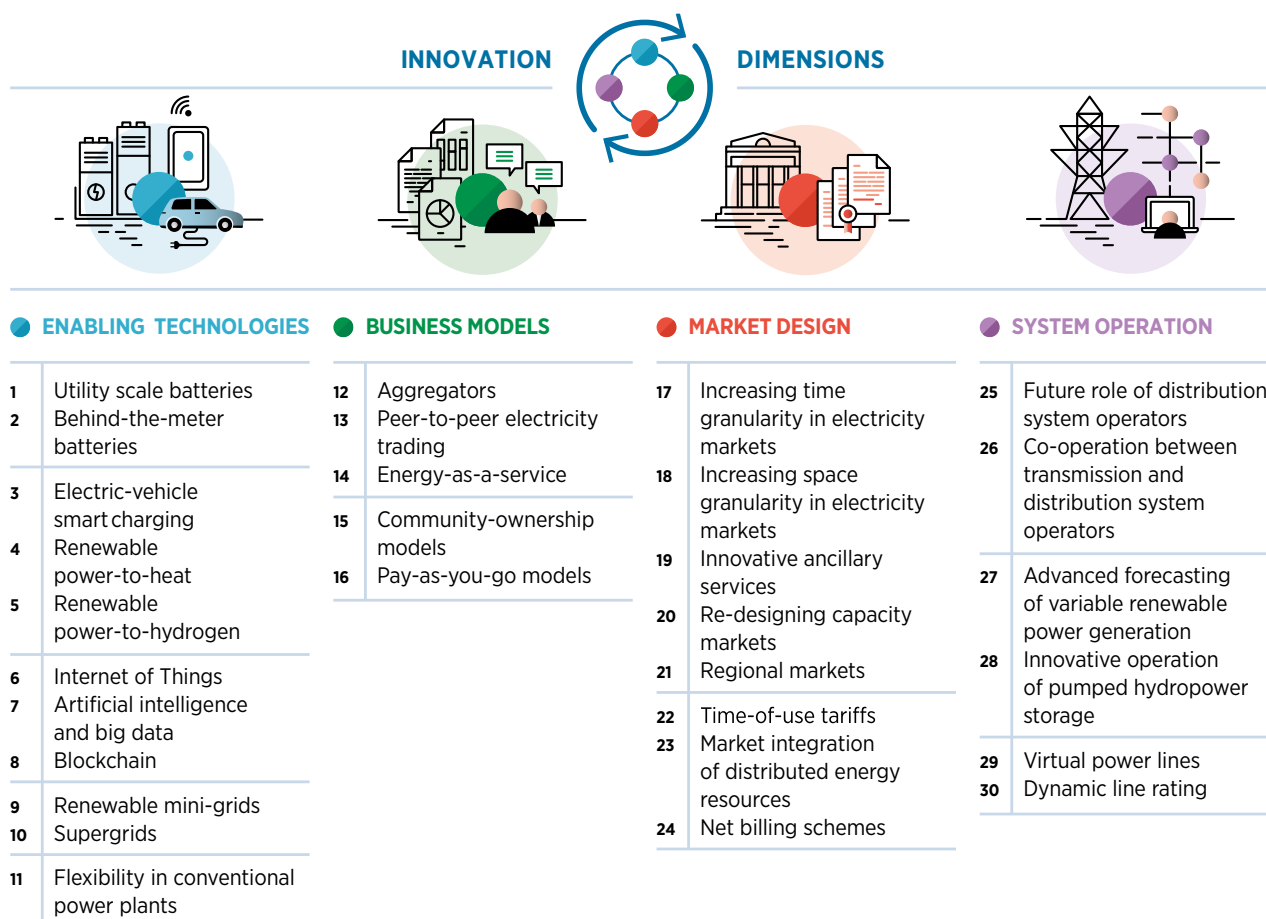

This brief provides an overview of new ways to operate pumped hydropower storage (PHS) to provide greater flexibility to the power sector and integrate larger shares of VRE in power systems. The innovative operation of PHS and its complementarity with other power generating technologies offer plenty of opportunities for VRE integration. PHS represents over 10% of the total hydropower capacity worldwide and 94% of the global installed energy storage capacity (IHA, 2018).

Known as the oldest technology for large-scale energy storage, PHS can be used to balance the grid, complement other renewable energy infrastructure and facilitate effective supply shifts.

PHS has the ability to actively absorb surplus power from the grid, making it a more cost-effective flexibility option than technologies such as batteries, interconnections or Power-to-X.

The brief is structured as follows:

- I [Description](#)
- II [Contribution to power sector transformation](#)
- III [Key factors to enable deployment](#)
- IV [Current status and examples of ongoing initiatives](#)
- V [Implementation requirements: Checklist](#)



I. DESCRIPTION

Traditionally, a pumped hydro storage (PHS) facility pumps water uphill into a reservoir, consuming electricity when demand and electricity prices are low, and then allows water to flow downhill through turbines, generating electricity when demand increases and electricity prices are higher (GE Power, 2017). Currently, PHS systems are the primary technology used to provide electricity storage services to the grid, accounting for

161 gigawatts (GW) of installed global storage capacity (IHA, 2018).

IRENA's global roadmap calls for a two-thirds increase in hydropower installed capacity, to 2 147 GW, by 2050. In other words, around 850 GW of new installed capacity is required in the next 30 years. As part of that target, PHS would need to double, reaching 325 GW (Figure 1) (IRENA, 2019b).

Figure 1 Growth in PHS installed capacity by 2050

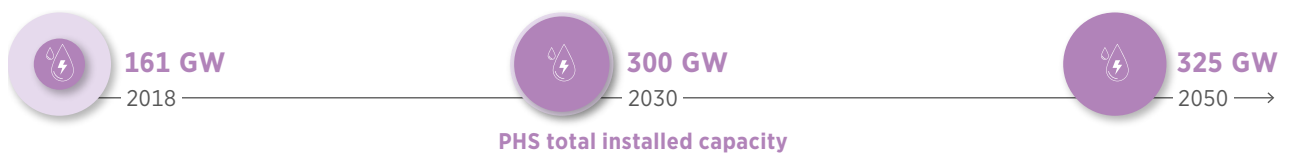

Source: IHA (2018); IRENA (2019b).

Note: PHS = pumped hydropower storage.

The transition to renewable energy sources, particularly wind and solar, requires increased flexibility in power systems. Wind and solar generation are intermittent and have seasonal variations, resulting in increased need for storage to guarantee that the demand can be met at any time.

vary from 1.8 to 50 USD per megawatt-hour (MWh) and short-term energy storage costs vary from 370 to 600 USD per kilowatt (kW) of installed power generation capacity when dam, tunnel, turbine, generator, excavation and land costs are considered (Hunt *et al.*, 2020).

Short-term energy storage solutions with batteries are being used to resolve intermittency issues. However, the alternative for long-term energy storage that is usually considered to resolve seasonal variations in electricity generation is hydrogen, which is not yet economically competitive (IIASA, 2020). PHS can provide long-term energy storage at a relatively low cost and co-benefits in the form of freshwater storage capacity. A study shows that, for PHS plants, water storage costs vary from 0.007 to 0.2 USD per cubic metre, long-term energy storage costs

Innovation has driven development in the operation of PHS stations, both in mechanical and digital operation. Digitalisation, for instance, is playing a prominent role in the improvement of PHS facilities. Innovations in the design, operation and maintenance of PHS; remote monitoring; and predictive maintenance have reduced the capital and operational costs of PHS systems, raising their attractiveness to potential investors. Furthermore, with increasing shares of VRE in the system, PHS can be a valuable enabler of increased flexibility.

Pumped hydropower storage systems

PHS systems can be divided into two main categories according to their operational design: **open-loop systems**, where the PHS facility is continuously connected to a naturally flowing water source, and **closed-loop systems**, where the PHS facility is isolated from any naturally flowing water source.

PHS systems can be integrated with battery storage; irrigation projects; or systems where the ocean, a lake or a river is used as the lower reservoir.

A variety of configuration schemes enable PHS to integrate more VRE into power systems:

CONVENTIONAL PHS: This type of system guarantees rapid start-up and adjustable power output, depending on demand. It also absorbs surplus VRE generation in the system, while minimising losses. Existing conventional hydropower plants can be retrofitted with pumping systems to integrate PHS capabilities. Currently, PHS can be considered a very versatile energy storage solution owing to its functionality over a wide range of timescales.

COUPLED SCHEMES (PHS + VRE): A VRE generation plant coupled with a PHS plant can pump water to the upper reservoir(s) of the PHS plant to minimise curtailment. The PHS would be then effectively acting as a behind-the-meter battery.

- **VRE with PHS as storage on site:** In this type of system, a wind or solar power plant would be installed in proximity to a PHS plant. The PHS will serve as on-site storage for the VRE plant, firming its intermittent supply.

- **VRE technologies integrated into PHS facilities:** Floating photovoltaic (PV) systems can be installed in the upper and lower reservoirs of a PHS facility, creating a hybrid model that can take advantage of existing high-voltage grid connections. Schemes with floating PV, where PV panels are installed on the water rather than on land, can provide other potential advantages, such as:

- increasing the efficiency and productivity of land and water usage
- reducing evaporation losses, especially in the case of floating solar, by shading the water
- increasing solar cell efficiency through water cooling (World Bank Group, ESMAP and SERIS, 2019)
- taking advantage of existing transmission infrastructure and readily combining with storage capabilities to provide dispatchable, uninterrupted and flexible power generation.

The schemes mentioned are summarised in Figure 2.

Figure 2 Configuration schemes for pumped hydropower storage and renewables

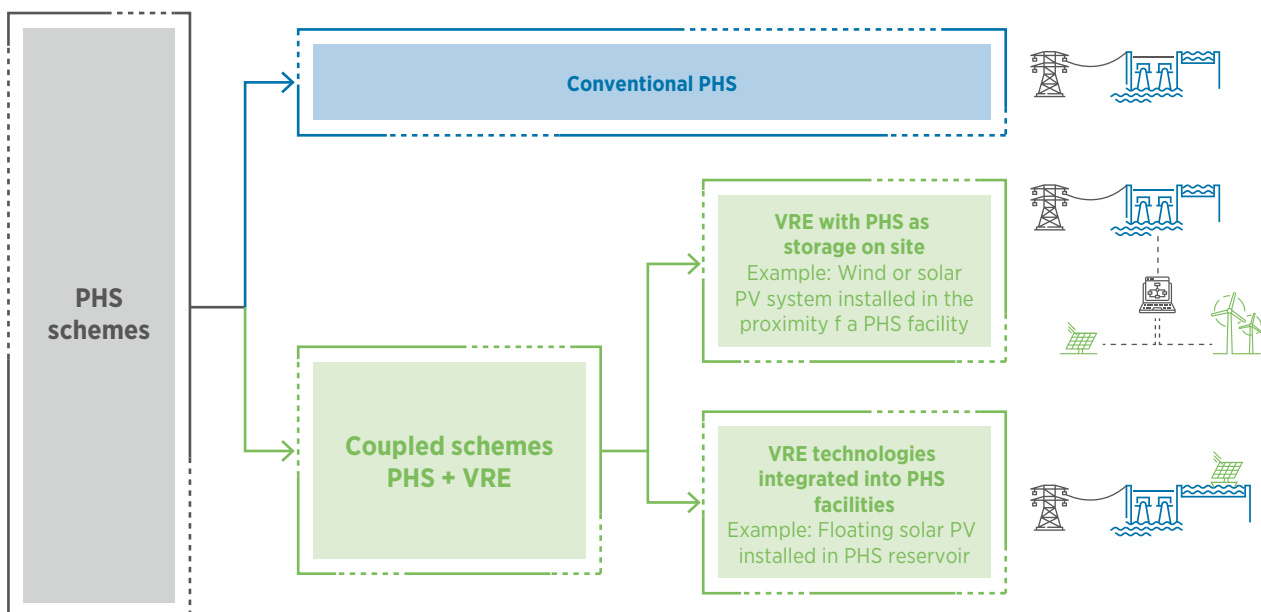

Note: PHS = pumped hydropower storage; VRE = variable renewable energy.

II. CONTRIBUTION TO POWER SECTOR TRANSFORMATION

Overall, in its different forms and applications, PHS is providing new flexibility options for the operation of power systems, balancing the variability of other renewable sources – such as wind and solar – and maintaining grid stability. PHS can operate from the instantaneous scale (using synchronous rotational inertia provided by fixed-speed turbines), to minutes and hours, up to the seasonal scale for long-term storage.

The complementarity between hydropower and VRE sources can range from daily to seasonal (yearly) generation patterns.

The synergies between hydropower and other renewable energy technologies in system operation have potential benefit for (i) the cost-effectiveness of using hydropower to counteract the short-term variability of wind and solar generation and (ii) seasonal complementarities in resource patterns.

Figure 3 shows the contribution of the innovative operation of PHS in power systems.

Figure 3 Services to power systems enabled by innovative operation of hydropower plants

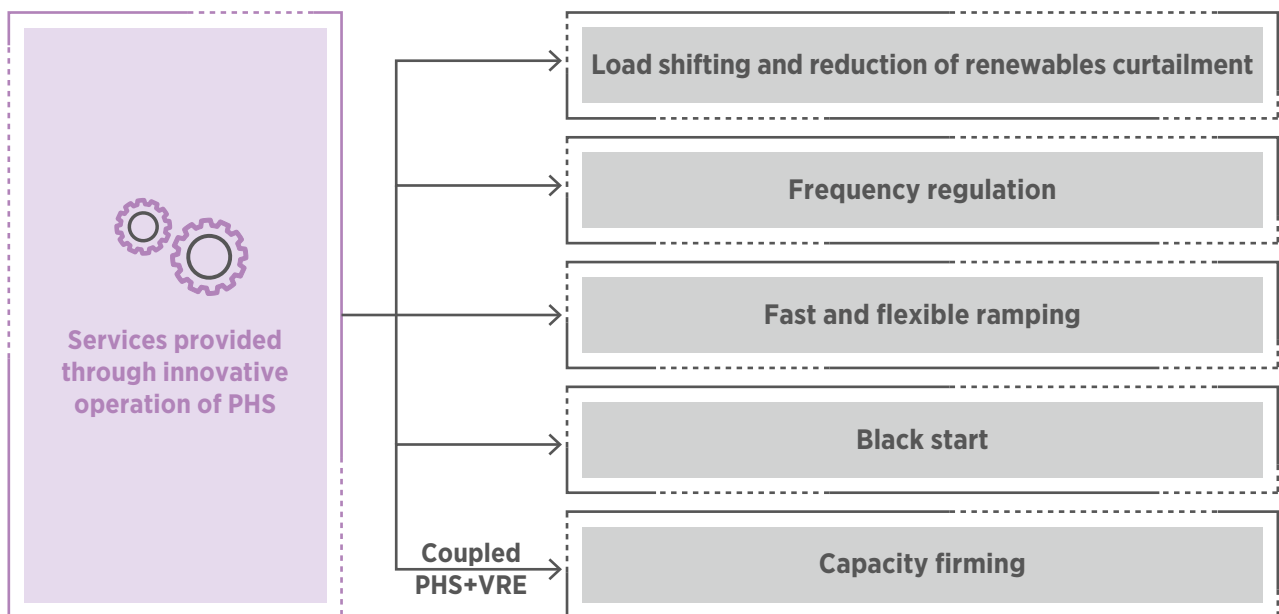

Note: PHS = pumped hydropower storage; RE = renewable energy; VRE = variable renewable energy.

Load shifting and reduction of renewable energy curtailment

Load shifting provided by PHS is a key service for system operators. For example, during the daytime, solar electricity can be used to pump water to the dam, which will then provide power capacity in the evening or during cloudy periods. In this way, curtailment can be mitigated by storing any surplus of electricity, which can then be used during periods of high demand. By increasing flexibility, the overall efficiency of the system is also positively impacted.

La Muela PHS facility in Spain is one of the largest PHS facilities in Europe. Figure 3 shows the demand and wind generation on 2 February 2019 in Spain, together with the PHS plant activity. The plant pumps water to the upper reservoir when demand is lower and wind production is relatively high and it generates power in the evening when demand is higher and wind production decreases. Figure 3 shows the daily complementarity of the PHS operation and wind energy generation; more benefits could be reaped from the complementarity of these resources on a longer-term basis (weeks, months).

Figure 4 Use of the flexibility provided by a PHS

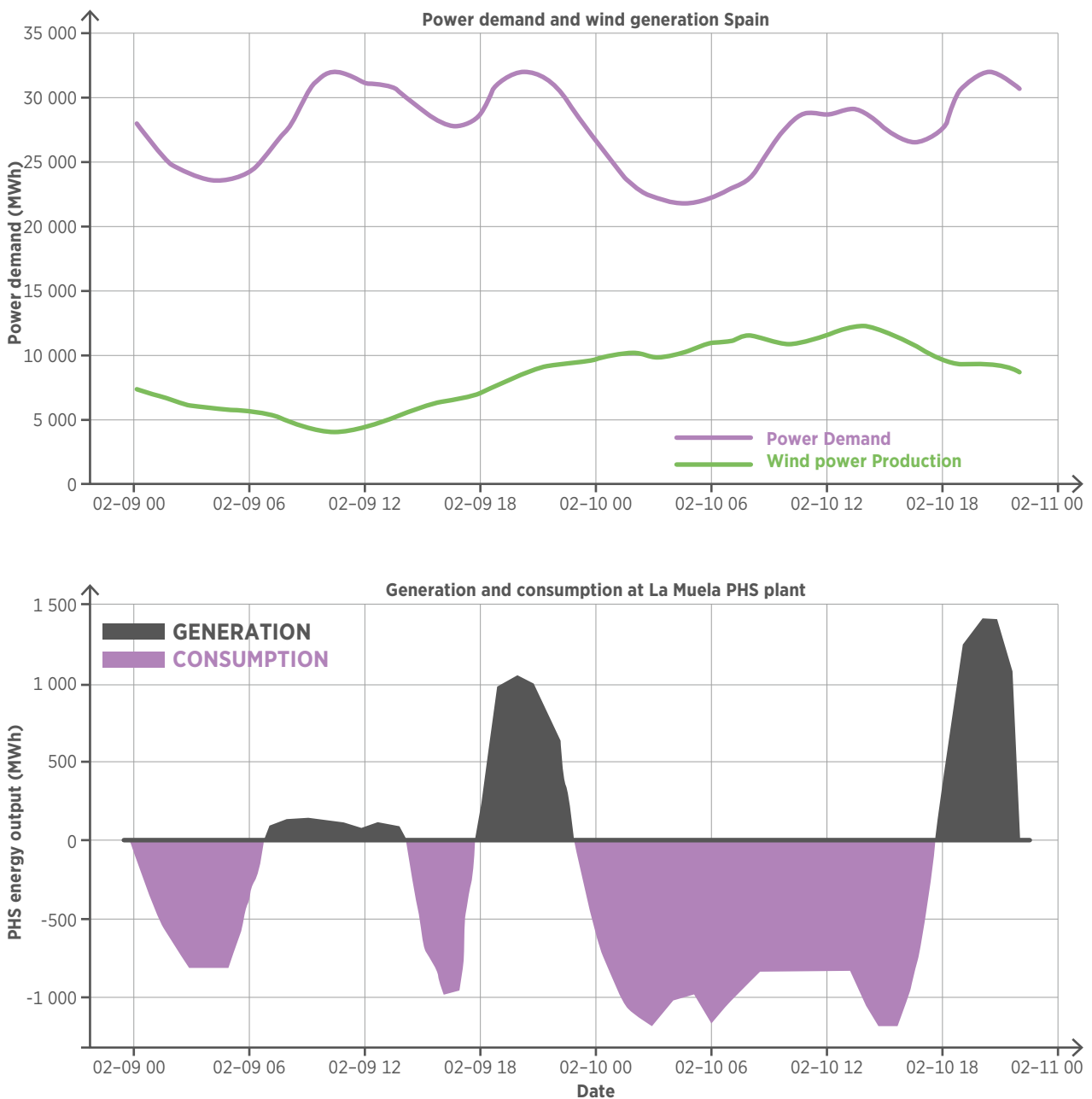

Source: Iberdrola.

The southernmost island of Japan, Kyushu, is home to three PHS plants, operated by the Kyushu Electric Power Company. With 8.07 GW of installed solar capacity, Kyushu has one of the highest VRE shares in Japan. On 3 May 2018, PV output reached 6.21 GW (81% of peak demand on that day) at around 13:00. The surplus of solar energy generated was used to pump water to the upper reservoirs in the island’s PHS plants, and thermal power generation was curtailed to accommodate the large amount of solar energy.

In this case, PHS helped to avoid complete shutdown of the thermal power stations by absorbing the surplus solar energy. This helped maintain their efficiency and response times, as thermal power stations can take anywhere from 2 to 8 hours to start, depending on the technology used. Moreover, PHS hydropower generation was used during times of lower PV output to meet demand peaks. Figure 5 shows the power supply and demand balance in Kyushu on that day.

One of the plants in Kyushu, the Omarugawa PHS power plant, featured variable speed generation systems with speeds of 576 to 624 revolutions per minute and a pump head of over 700 metres. This was an unprecedented installation for its time among PHS plants and supported the integration of a high share of VRE on the island of Kyushu (Nagura *et al.*, 2010).

Frequency regulation

PHS is characterised by its fast response to balance variations between electricity supply and demand, keeping the balance between active power load and generation in the system to prevent frequency problems (IRENA, 2016). Also, PHS provides reactive power control as support to keep voltages in the system at acceptable levels.

The latest innovations in PHS technology, such as variable speed turbines and ternary systems, have further unlocked frequency control services. Variable speed turbines, as alternatives to traditional fixed-speed turbines, allow for power regulation during both pumping and generation modes, which increases system efficiency and flexibility. Ternary systems, which consist of a motor-generator and a separate turbine-and-pump set, allow for generation and pumping modes to operate in parallel, which leads to finer frequency control.

These innovations offer increased grid flexibility through load following and power regulation. Variable speed pump-turbines provide several advantages over fixed-speed pump-turbines to PHS projects, such as a wider range of operation, quicker response time and higher efficiency. They also allow for adjustable power consumption while pumping, hence allowing

Figure 5 Power supply and demand balance from Kyushu, 3 May 2018

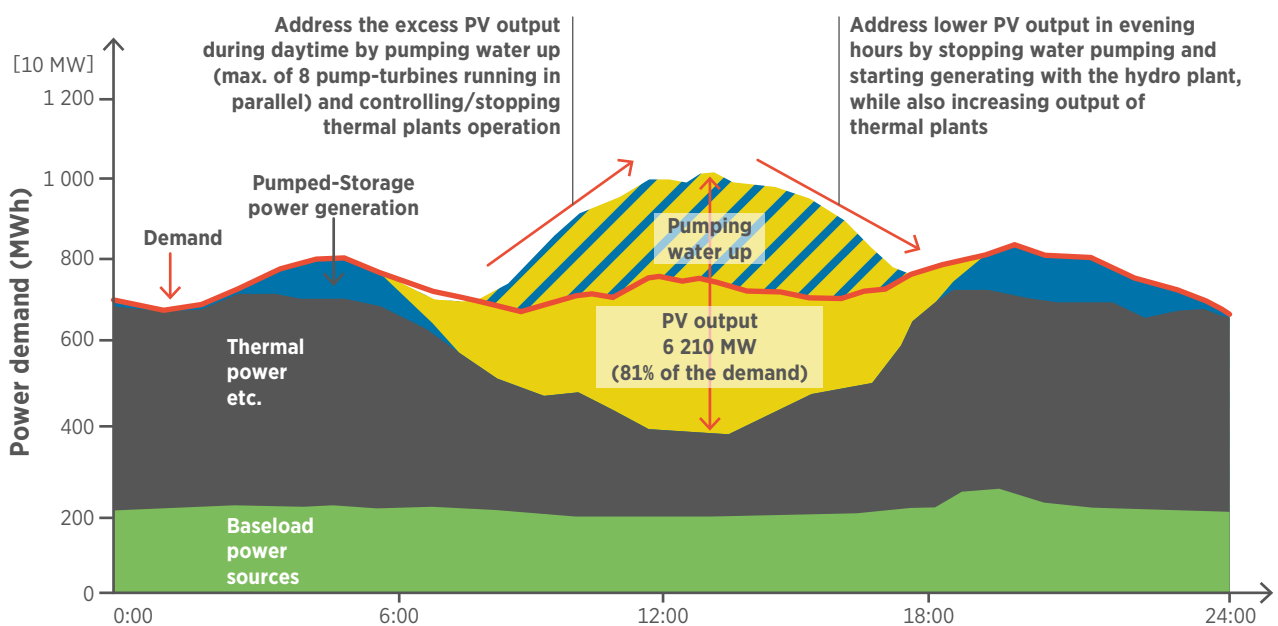

Source: Kyushu Electric Power Company.
 Note: PS = pumped storage; PV = photovoltaic.

for refined frequency control. Ternary systems permit the simultaneous operation of the turbine and the pump. This eliminates the time needed to switch between pumping and generation, which allows for additional flexibility and a quicker response time. Furthermore, owing to the nature of fixed-speed pump-turbines and ternary systems, mechanical inertial response can suffice to resist rapid changes in the grid (IHA, 2018).

The Frades II PHS facility in Portugal, a 780 megawatt (MW) project, is one of the few PHS facilities to use variable speed turbines (XFLEX Hydro, 2019a). The station contributes to frequency regulation in a grid with around 20% wind electricity generation (IHA, 2018). Variable speed turbines also allow the power plant to stay stable for 600 milliseconds: four times longer than fixed-speed turbines. This can help system operators prevent large-scale outages (XFLEX Hydro, 2019a).

Alternatively, coupling battery storage to a conventional PHS system would result in valuable services for system operation that could enhance frequency regulation of the plant. Battery storage can provide an instantaneous response time, while PHS can provide significantly larger amounts of energy than other storage systems. Such as system was implemented at the Kraftwerksgruppe Pfreimd power plant in Bavaria, Germany, when a 12.5 MW lithium battery storage system was installed to complement the existing PHS facilities (combined 137 MW capacity) at the site (Energy Storage, 2018). This system contributes to a secure energy supply by providing primary and secondary control power and reserve capacity to the grid.

Fast and flexible ramping

Advancements such as variable speed turbines have provided flexible ramping capacities, which refers to a generator's ability to rapidly increase or decrease its output, according to changes in the forecasted net load. Moreover, they have allowed PHS facilities to reach full output in less than 30 seconds when already connected to the network.

Challenges caused by VRE intermittency from resource fluctuation or weather events could be counteracted by the rapid ramping response provided by PHS.

System operators can take advantage of PHS facilities with second scale ranges to reach full output, maintaining a reliable and stable system while integrating higher shares of VRE. PHS is also being used to balance the so-called duck curve, where the difference between electricity demand and solar energy production around sunset reaches a maximum.

For example, the Kops II PHS facility in Austria, which features variable speed turbines, can reach a maximum output of 180 MW in 20 seconds. Another example is the Dinorwig PHS facility in Wales, the largest PHS facility in Europe, which can reach a full load of 1.8 GW in 16 seconds.

Kruonis PHS facility in Lithuania supported the Lithuanian grid efficiently with over 400 MWh when the NordBalt interconnector between Lithuania and Sweden failed on 18 May 2016 (LT Daily, 2016). In another example, the Fengning 2 Pumped Storage Power Station in China, with a planned capacity of 1.8 GW, plays an essential role in balancing generation from wind and solar energy projects to supply the Beijing-Tianjin-North Hebei grid (Hopf, 2020).

Black start

Hydropower plants are well suited to providing black start services, as long as the reservoirs store enough water to power turbines without any special preparation for black start operation. Minimal station power is needed, since fuel preparation and cooling are not required. Moreover, hydropower generators have significant inertia and high enough ramp rates (for changing power output) to help stabilise system frequency. Many hydropower generators are large enough to supply adequate power to energise the transmission system, provide station power to start up other generating plants, and pick up loads.

PHS units have almost all the advantages of conventional hydro units. However, economical dispatch may deplete the upper ponds of PHS systems, so PHS units are adequate for black start only if some water is always held in reserve for it (Garcia *et al.*, 2019).

The Cruachan PHS plant in Scotland, with a capacity of 440 MW, can achieve full load in 30 seconds and can maintain that level of production for over 16 hours if needed, guaranteeing a stable supply feed for system operation. Besides balancing services, the plant can also provide black start capability to the National Grid, the system operator (Drax, 2019).

**Capacity firming
(when connected to an on-site VRE generator)**

Coupling VRE power plants and PHS systems permits them to provide a firm generation, turning the plant into a dispatchable power plant. This increases the reliability and efficiency of system operation, and, as a result, balance energy generation and complements different renewable energy generation sources for a stable energy supply.

An innovative form that is under development, such as in the pilot project in Gaildorf, Germany, places smaller PHS reservoirs at the base of wind turbines to provide each turbine with its own storage capabilities. The reservoirs are connected via an underground penstock to a pumped-storage power station in the valley that can provide up to 16 MW in power. The electrical storage capacity of the power plant is designed for a total of 70 MWh (Max Bögl, 2018).

The Gorona del Viento wind-PHS hybrid power plant, located at El Hierro, Canary Islands, Spain, has reduced the small island’s dependency on diesel generators.

This has been done by pumping water using surplus wind energy generation to the upper reservoir in the PHS facility and then using the PHS facility to meet the energy demand when wind speeds are too low to provide sufficient production levels. El Hierro was able to reach 4 800 consecutive hours (24 days) of 100% renewable energy generation in 2019, showing the potential for PHS to integrate renewables into system operation (Gorona del Viento, 2019).

Figure 6 shows the energy demand and generation data of a full day on El Hierro (5 September 2018) when the supply was successfully met with electricity generated from wind and PHS. The figure displays how wind energy curtailment is avoided; for instance, excess electricity generated from wind energy in the first 8 hours of the day is used to pump water into the upper reservoir. The operation of the energy system on El Hierro benefits directly from PHS, while mitigating curtailment and eliminating the need to cover energy demand with diesel generators.

Figure 6 Gorona del Viento demand and generation, 5 September 2018

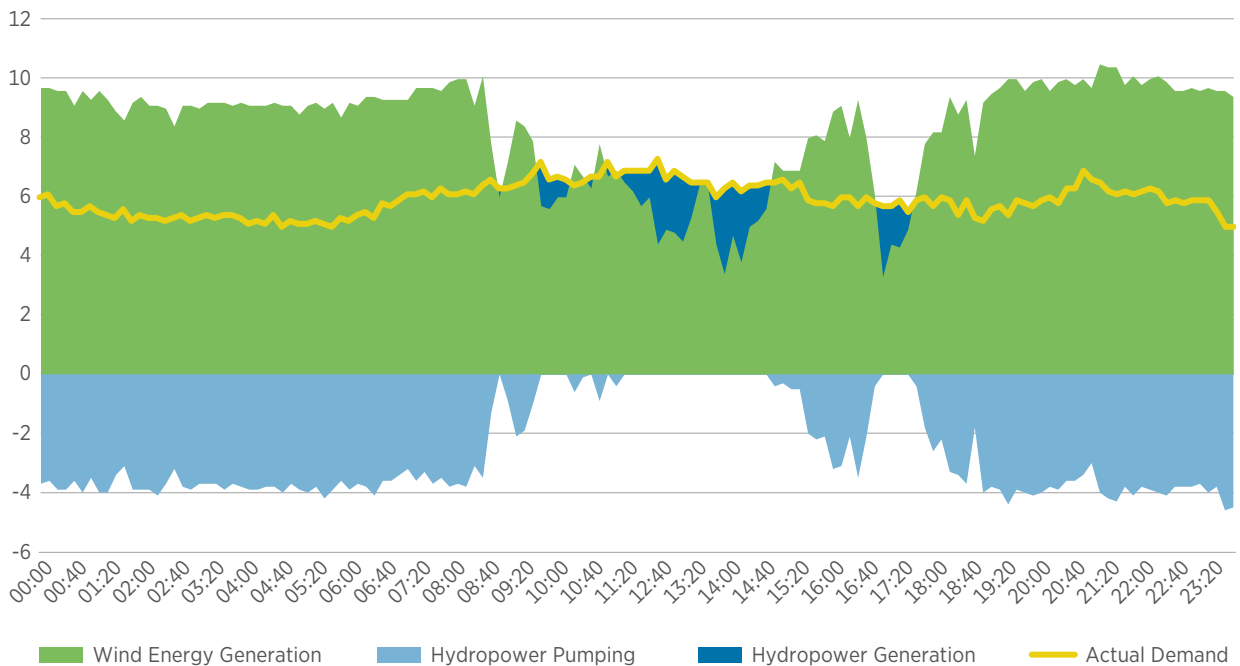

Based on data from Red Eléctrica de España.

III. KEY FACTORS TO ENABLE DEPLOYMENT

A summary of the key factors to enable deployment is illustrated in Figure 7.

Figure 7 Key factors to incentivise innovative ways to operate pumped hydropower storage in combination with variable renewable energy

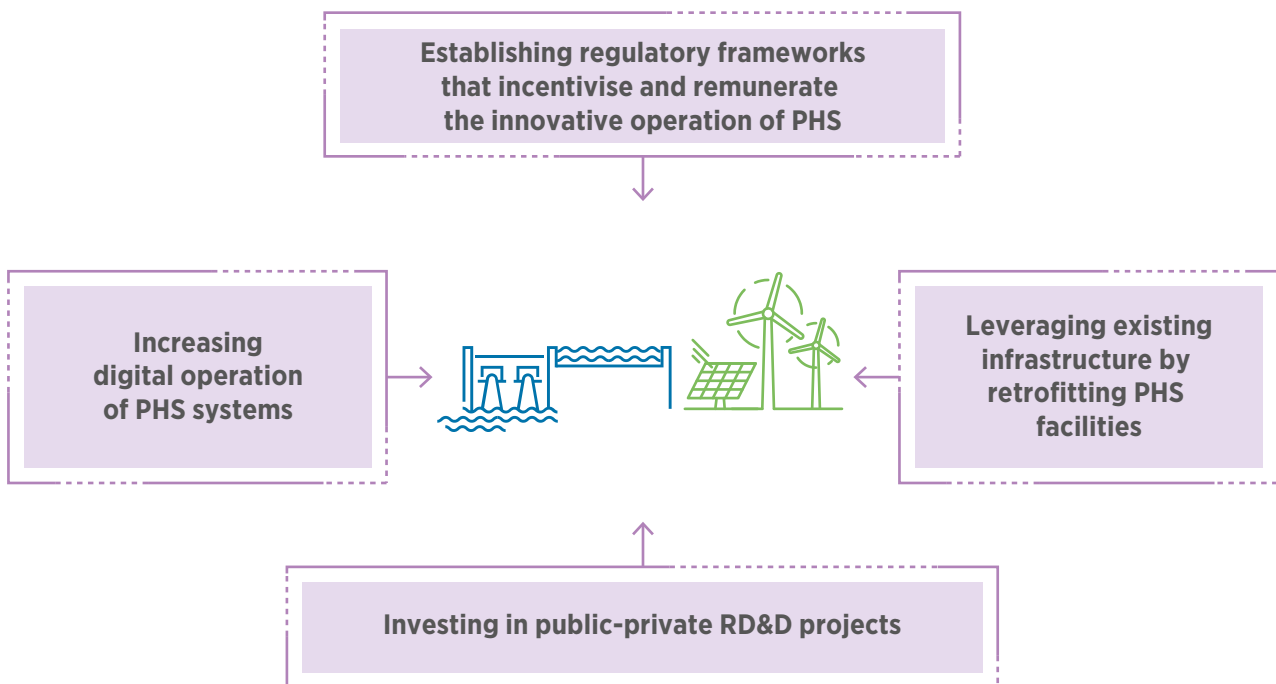

Note: PHS = pumped hydropower storage; RD&D = research, development and deployment.

Establishing regulatory frameworks that incentivise and remunerate the innovative operation of PHS

PHS stations have been in operation for decades. In the past, PHS was built to complement large, inflexible generation, such as nuclear plants, for arbitrage on a diurnal basis. However, the increased VRE share in the systems demands new ways to operate flexible power plants. To compensate for the increased variability of wind and solar generation, existing PHS systems tend to operate with increased start-stops and with decreased total hours of generation, resulting in a less predictable revenue regime and reduced bankability for future projects.

Therefore innovative policies and regulations must be tried and adopted to incentivise and remunerate such flexible facilities for the provision of ancillary services. For more about this, see *Innovation Landscape Brief: Innovative ancillary services* [IRENA, 2019c]).

In liberalised markets where vertical integrated utilities have been unbundled, enabling revenue stacking from the provision of different services can incentivise innovative operation of PHS systems. New revenue streams can result from ancillary service provision, energy arbitrage or capacity payments.

- **Ancillary services:** Where ancillary service markets or rules are in place, PHS facility owners could obtain revenue by offering ancillary services – such as frequency control, black start, active and reactive power regulation – to network operators to maintain the system in balance.
- **Energy arbitrage:** Where wholesale electricity markets are in place, PHS facility owners could obtain revenue by purchasing off-peak (cheaper) electricity to pump water when VRE generation is low and then sell back electricity at peak time (more expensive) when demand is high and VRE generation is still low. With further integration of VRE, this disparity is getting smaller and thus diminishing profits from arbitrage.
- **Capacity payments:** Where such regulations are in place, PHS could obtain revenue by providing services to system operators to ensure a certain supply level for a certain (predefined) period of time, thereby helping with system adequacy.

Different countries and contexts need to adopt different frameworks that can maximise the potential of PHS. One such example lies in Ireland. As the only PHS facility operating in the Irish Single Electricity Market, the Turlough Hill PHS station (292 MW capacity) uses all three revenue streams. It provides several ancillary services, such as black start, reactive power and operating reserve. The transmission system operator EirGrid recommended the addition of other services, such as synchronous inertial response and fast frequency response (Wänn and Leahy, 2014).

Another way to increase flexibility provided by generation plants, in addition to allowing revenue stacking and innovative ancillary services, is to increase the time granularity in electricity markets. This would lead to prices that better reflect the conditions on the market in shorter time intervals (see *the Innovation Landscape brief: Increased granularity in electricity markets* [IRENA, 2019d]).

In vertically integrated markets, the policy and regulation frameworks must be consistent with the country energy roadmap to guarantee the best use of renewable resources.

For example, several policies were issued in China in 2014 to facilitate the development of new PHS stations. A two-part feed-in tariff was implemented: the first part reflected the value of the ancillary services provided and the second reflected the value of the plant's power generation. This ensured remuneration for the different services that can be provided by a single PHS plant, which can encourage investment in the technology and its diverse uses in system operation (Zhang, Andrews-Speed and Perera, 2015).

Increasing digital operation of PHS systems

Innovative operation of energy systems has been and will continue to be positively influenced by digitalisation. In the case of PHS, many digital breakthroughs optimise the operation of the plant, such as smart coupling (with batteries or with VRE plants), operation monitoring equipment and generation forecasting through machine learning (IHA, 2017a) (for more information on digital technologies in the power sector see *Innovation Landscape brief: Artificial intelligence and big data* [IRENA, 2019e]; *Innovation Landscape brief: Internet of things* [IRENA, 2019f]).

In addition to optimising the operation and increasing the efficiency of the PHS, the benefits of digital innovations include decreasing operation and maintenance costs. Such applications include maintenance robots, virtual reality training for operation personnel and remote-control maintenance technologies. For example, Hydro-Québec says its underwater monitoring and maintenance robot generates around USD 1.4 million (CAD 2 million) of savings annually (Lorinc, 2016). The robot has a positioning system to pinpoint its own location and that of anomalies, as well as cameras to display graphical data for the monitoring team. This makes inspections safer and quicker and thereby reduces operating downtime (Hydro-Québec, 2010).

Portugal's utility Energias de Portugal (EDP) has benefited from digital solutions (*i.e.* real-time measurements using big data and computational fluid dynamics) to determine the high- and low-stress zones of the turbines in the Alqueva II PHS plant (GE Renewable Energy, 2019). This analysis resulted in an increase of 50% in the operating range for its two-unit 260 MW PHS, enabling higher flexibility when operating the plant with other VRE. In addition, this enhancement provided EDP with additional revenue from the plant, which could be used to improve its ancillary services for the secondary reserve market (CAREC Program, *n.d.*).

Leveraging existing infrastructure by retrofitting PHS facilities

Retrofitting existing PHS plants with modernised and innovative components can improve their operation and add significant benefits to the system operation. Components such as variable speed turbines can improve response time and expand the operating range of the facility, giving it increased revenue streams, where applicable, and making PHS more attractive to investors, leading to further integration of new VRE plants.

Additionally, combining existing PHS projects with other VRE systems, such as floating PV, can decrease capital expenditure costs, first because of the technology's modular features, which can help reduce the construction times of floating PV and, second, through the use of already existent transmission and distribution grid connections.

A relevant case is the floating solar PV plant integrated into an existing PHS facility in Alto Rabagão, Portugal. This pilot project consists of 840 PV panels with a total of 220 kW power output and an estimated annual energy output of 300 MWh. This scheme proved to be a success in its first year of testing, producing 15 MWh more than previously estimated (EDP, 2017).

Investing in public-private research, development and deployment projects

More economic resources assigned to the research, development and deployment of PHS combined with VRE and/or batteries could showcase their benefits and complementarities. The overall enhancement of existing PHS and new synergies with other renewable energy technologies can, among others benefits, provide a lower-risk portfolio and raise the confidence of investors, who could therefore further invest in renewable technologies, leading to higher shares of VRE in power systems.

Enabling such projects calls for the establishment of more partnerships with the private sector and the involvement of those partners in the development or enhancement of PHS technologies. In this context, another prominent example is Hidrocaleras, a pilot project to be developed in the Spanish region of Cantabria. The project consists of a scalable PHS plant with seawater, equipped with 50 MW turbines. Several European-based actors are involved, including engineering companies, banks and research institutions, led by Cobra Infraestructuras Hidráulicas. The project was approved by the local and regional administration (Grupo Cobra, 2018).

IV. CURRENT CONTEXT AND ONGOING INITIATIVES

Table 1 contains some of the key insights into existent PHS facilities.

Table 1 Current status and examples of leading PHS initiatives

Indicator	Key facts
Geographies where the innovation is deployed	Argentina, Australia, Austria, Belgium, Bosnia and Herzegovina, Brazil, Bulgaria, China, Croatia, Czech Republic, France, Germany, India, Iran, Ireland, Italy, Japan, Lithuania, Morocco, Norway, Philippines, Poland, Portugal, Republic of Korea, Romania, Russian Federation, Serbia, Slovenia, South Africa, Spain, Sweden, Switzerland, Thailand, Ukraine, United Kingdom, United States of America ^a
Installed PHS capacity (GW)	161 in 2018 ^b
Forecasted installed capacity	By 2030: 300 GW ^c By 2050: 325 GW ^c
Levelised cost of pumped storage (USD/MWh)	15-year lifetime: 150–200 ^d 40-year lifetime: 186 (compared to 285 USD/MWh for Li-ion battery facility) ^e 100-year lifetime: 58 ^e
Capital expenditure for PHS construction^f (USD/kW)	Low end: 617 Medium end: 1 412 High end: 2 465

Note: PHS = pumped hydropower storage.

^aIHA (2019).

^bIHA (2018).

^cIRENA (2019b).

^dLazard (2016).

^eGiovinetto and Eller (2019).

^fCalculated using the average annual capital expenditure between 2003 and 2019 for 19 countries from IRENA database. Lower-end costs can be attributed to low labour and construction costs (e.g. China, Thailand) or large-scale installations. Higher-end costs can be attributed to high labour costs (e.g. Japan, Switzerland) or small-scale installations.

Table 2 provides a non-exhaustive sampling of current projects benefiting from the innovative operation of PHS plants.

Table 2 Current status and examples of leading PHS initiatives

PHS scheme	Location	Description	Value added
PHS coupled with floating PV system	Montalegre, Portugal	This is the world's first hybrid PV and hydroelectric dam power plant system and has a total capacity of 68 MWp. The dam adds an additional 220 kWp through the floating PV installation (Prouvost, 2017).	The panels generate during the day and save hydropower to use during the evening peak demand (Carr, 2017). After the first year of operation, the facility generated around 5% more than its initially projected annual generation target of 300 MWh (EDP, 2017).
PHS with ternary systems	Vorarlberg, Austria	The three ternary units installed in Kops II allow the parallel operation of the 180 MW turbine and the 150 MW pump (Pöyry, 2014).	This PHS facility is considered fast, as it reaches full load in 20–30 seconds, enabling it to provide a wider range of ancillary services.
PHS coupled with wind power plant and battery system	El Hierro, Canary Islands, Spain	In the Gorona del Viento project, five wind turbines with a generating capacity of 11.3 MW are connected to the PHS station, which is used to store surplus energy and generate power when wind speed is insufficient.	The project played a role in the island of El Hierro reaching 56% wind power in 2018 (Gorona del Viento, 2018). In August 2019, the island's demand was completely met by renewable energy sources for 24 consecutive days.
Conventional PHS systems	Kyushu, Japan	These three PHS stations on the Japanese island of Kyushu have a storage capacity of 2.3 GW and are operated by Kyushu Electric Power Co.	The use of PHS on the island assists the integration of over 8 GW of solar PV by reducing its curtailment. PHS also prevents the complete shutdown of the island's baseload sources, such as nuclear and thermal power. This reduces financial losses due to the slow start time for those technologies.
PHS with variable speed turbines (with doubly fed induction machine)	Frades II, Portugal	The 780 MW project is one of the few PHS facilities to use variable speed turbines (XFLEX HYDRO, 2019a).	The facility contributes to frequency regulation in a grid with around 20% wind generation (IHA, 2018). Variable speed machines enable wider operating range, faster response and higher efficiency in PHS plants (Voith, 2019).
Conventional PHS	Dinorwig, Wales, United Kingdom	This is the largest PHS facility in Europe, with an 11 GWh storage capacity. It consists of six 300 MW reversible turbines. It is able to reach full load in 16 seconds.	The facility supports the grid by providing peak load electricity. Owing to its fast response time, it also provides electricity in rapid changes in demand, for example during "TV pickup", where households simultaneously use electric kettles and other appliances during commercial breaks, and demand surges. Dinorwig is also able to provide black start services.
Conventional PHS	Cortes de Pallás reservoir, Spain	La Muela has a total generating capacity of 1 517 MW, with seven reversible turbines.	The facility's average annual output of around 1 625 GWh is enough to provide the electric consumption of close to 400 000 households. La Muela also dedicates 40% of its production to ancillary services for real-time system management.

Note: PHS = pumped hydropower storage; PV = photovoltaic.

Table 3 provides a non-exhaustive sampling of future projects benefiting from the innovative operation of PHS plants.

Table 3 Future deployment PHS projects and schemes



PHS scheme	Location	Description	Value added
PHS coupled with floating solar PV technology	Kruonis, Lithuania	The pilot floating PV retrofit will consist of a 60 kW PV system. The floating PV system could have a capacity of 200–250 MW. It would be installed at the existing 900 MW Kruonis PHS facility.	The system would allow the utility to provide reliable frequency control and primary reserve services and improve its connectivity to the integrated pan-European market (Hydro Review, 2019).
PHS coupled with onshore wind project	Gaildorf, Germany	In this pilot project, the foundations of the wind turbines are used as upper reservoirs of a PHS facility. They are connected to a pumped-storage power station in the valley that can provide up to 16 MW in power. The electrical storage capacity of the power plant is designed for a total of 70 MWh (Max Bögl, 2018).	Surplus wind electricity is stored in the upper reservoirs and helps to smooth the wind generation output.
PHS coupled with wind and solar PV technology	Kidston, Australia	The projected large-scale hydro 250 MW PHS, with a total of 8–10 hours' storage, would combine a total capacity of 320 MW solar PV and 150 MW wind (Iannunzio, 2018).	The project is expected to provide dispatchable and reliable renewable energy at peak demand, being able to store solar energy during the day and release it during the morning and evening peak periods through the hydro system. It can reduce losses associated with importing electricity from the grid for the PHS scheme, as well as mitigate the risk associated with rising overnight electricity prices when PHS facilities are usually "recharging" (Energy Magazine, 2018).
PHS coupled with solar PV technology	Atacama Desert, Chile	The Valhalla project will send intermittent generation from the 600 MW Cielos de Tarapacá solar PV farm to the 300 MW Espejo de Tarapacá PHS plant to convert it into a dispatchable power plant.	The project plans to deliver continuous baseload power to fill about 5% of northern Chile's baseload demand. It would be the first to demonstrate that baseload power can be generated from a utility-scale PV plant (Andrews, 2017).
PHS coupled with solar PV technology	Hatta, United Arab Emirates	The Hatta PHS facility, with a generation capacity of 250 MW, will use surplus electricity from the world's largest planned solar PV installation, the 5 GW Mohammed bin Rashid Al Maktoum Solar Park.	The PHS facility is planned to reach 80% of peak capacity within 90 seconds, from zero. This fast response will prove very beneficial in balancing load within the power system in the United Arab Emirates and will be essential in reaching the country's target of 75% renewable power by 2050 (Gulf News, 2019).
PHS with variable speed turbines (with full size frequency converter)	Z'Mutt, Switzerland	A 5 MW variable speed pump-turbine will be installed with a full size frequency converter and optimisation software to enhance flexibility services.	The project will demonstrate optimum flexibility and power control at prototype scale. Service improvements will include fast power injection or absorption in pumping and generating modes, inertia emulation, and fast turbine starts, stops and transitions (XFLEX HYDRO, 2019b).

PHS scheme	Location	Description	Value added
PHS with variable speed turbines and hydraulic short circuit	Frades II, Portugal	Two variable speed machines will be run in hydraulic short circuit mode for added flexibility from a PHS site.	The project will demonstrate pumping working simultaneously with generation, using variable speed machines for added flexibility. Benefits will include extending power range and response; emulating virtual inertia; and improving operations, maintenance and efficiency using condition monitoring and smart controls (XFLEX HYDRO, 2019a).
PHS with hydraulic short circuit using fixed-speed machines and optimised equipment	Grand Maison, France; Alqueva, Portugal	Fixed-speed pumping will be operated simultaneously with units in generation mode, together with optimisation software for improved flexibility.	The project will allow frequency response when consuming power from the grid. At Grand Maison, a new Pelton turbine will be used to regulate the load and improve generating efficiency. At Alqueva, extended unit operation of fixed-speed reversible turbines will be tested, targeting an almost continuous power output from zero to rated power. Both demonstrations will implement advanced software to optimise performance (XFLEX HYDRO, 2019c).

Note: PHS = pumped hydropower storage; PV = photovoltaic.

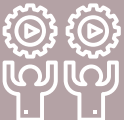

V. IMPLEMENTATION REQUIREMENTS: CHECKLIST

<p>TECHNICAL REQUIREMENTS</p> 	<p>Hardware:</p> <ul style="list-style-type: none"> • PHS facilities that fulfil grid connection requirements • For coupled schemes, wind and (floating) solar PV power plants • Where applicable, upgraded PHS facilities with new pump and turbine technologies for improved frequency control and power regulation • Operation monitoring equipment <p>Software:</p> <ul style="list-style-type: none"> • Optimisation software for the operation of hybrid systems, including PHS, VRE and batteries • Advanced weather forecasting tools for improved power generation forecasting • Automation of various processes and information exchange related to system operation
<p>POLICIES NEEDED</p> 	<ul style="list-style-type: none"> • Provision of an enabling environment supporting the deployment and scale-up of enhanced PHS with complementary VRE generation and/or storage systems • Policies that can help complement the seasonal variability and availability of various power generating resources
<p>REGULATORY REQUIREMENTS</p> 	<p>Wholesale market:</p> <ul style="list-style-type: none"> • Incentives for flexible operation, such as remuneration mechanisms and stacking revenues from various flexibility services • Increased time granularity in electricity markets providing better price signals closer to the real-time delivery of power • Innovative ancillary services, incentivising the provision of flexible services to system operators <p>Grid codes:</p> <ul style="list-style-type: none"> • Development of technical standards for the deployment of hybrid systems that create dispatchable renewable power plants, such as PHS coupled with VRE and batteries
<p>STAKEHOLDER ROLES AND RESPONSIBILITIES</p> 	<p>System operators:</p> <ul style="list-style-type: none"> • Together with regulators, define technical requirements for the provision of ancillary services needed for the integration of high shares of VRE into the system • Design and develop new dispatch strategies that consider the flexibility potential of PHS coupled with additional VRE and/or storage infrastructure <p>Generators:</p> <ul style="list-style-type: none"> • Participate in ancillary service markets, where established, providing flexibility options to system operators in addition to power supply and trade • Increase deployment of hybrid PHS-VRE schemes via the diversification of a power generation portfolio or via partnerships, such as co-operation with research and development institutes, equipment manufacturers, financial institutions, project developers

ABBREVIATIONS

EDP	Energias de Portugal	MWh	megawatt-hour
GW	gigawatt	PHS	pumped hydropower storage
GWh	gigawatt-hour	PV	photovoltaic
kW	kilowatt	VRE	variable renewable energy
MW	megawatt		

BIBLIOGRAPHY

Andrews, R. (2017), “The Valhalla solar/pumped hydro project”, Energy Matters, 27 December, <http://euanmearns.com/the-valhalla-solar-pumped-hydro-project>.

CAREC Program (*n.d.*), “Discussions on hydropower technologies”, Central Asia Regional Economic Cooperation Program, Asian Development Bank, CAREC Unit, Manila.

Carr, A. (2017), “First-ever hydro and solar power hybrid plant opens in Portugal”, The Weather Channel, 10 July, <https://weather.com/science/environment/news/portugal-alto-rabagao-dam-solar-hydro-power-panels-energy>.

Drax (2019), “Scottish Energy Minister visits Drax’s iconic Cruachan pumped storage hydro power station”, 24 October, www.drax.com/press_release/scottish-energy-minister-visits-draxs-iconic-cruachan-pumped-storage-hydro-power-station.

EDP (Energias de Portugal) (2017), “Pioneering floating photovoltaic solar project surpasses expectations”, EDP news, 4 December, <https://portugal.edp.com/en/news/2017/12/04/pioneering-floating-photovoltaic-solar-project-surpasses-expectations>.

Energy Magazine (2018), “World’s first integrated solar pumped hydro project”, 19 February, www.energymagazine.com.au/worlds-first-integrated-solar-pumped-hydro-project.

Energy Storage (2019), “Chile’s ambitious 561 MW PV and 300 MW pumped hydro project could begin next year”, www.energy-storage.news/news/chiles-ambitious-561mw-pv-and-300mw-pumped-hydro-project-could-begin-next-y.

Garcia, J. et al. (2019), *Hydropower Plants As Black Start Resources*, HydroWires, U.S. Department of Energy, Washington, DC, www.energy.gov/sites/prod/files/2019/05/f62/Hydro-Black-Start_May2019.pdf.

GE Power (2017), *Hybrid Solutions*, Atlanta, Georgia, <http://content.gepower.com/pw-hq/Hybrid%20Solutions%20Brochure/index.html#52>.

GE Renewable Energy (2019), “Alqueva II – Testing the Waters”, www.ge.com/renewableenergy/stories/testing-the-waters.

Giovinetto, A., and A. Eller (2019), *Comparing the Costs of Long Duration Energy Storage Technologies*, Navigant Research, Boulder, Colorado.

Gorona del Viento (2019), “El Hierro achieves 24 consecutive days of supplying its electricity from 100% renewable energy”, 8 August, www.goronadelviento.es/en/el-hierro-achieves-24-consecutive-days-of-supplying-its-electricity-from-100-renewable-energy.

Gorona del Viento (2018), “Informe central hidroeléctrica 2018 – Gorona del Viento, El Hierro”, www.goronadelviento.es/wp-content/uploads/2019/05/Informe-anual-Central-Hidro%C3%B3lica-2018-Gorona-del-Viento.pdf.

Grupo Cobra (2018), “Cobra infraestructuras hidráulicas will lead a public-private group to develop a project of a marine reversible hydroelectric plant in Cantabria”, 21 December, www.grupocobra.com/en/traducir.

Gulf News (2019), “Dubai hydroelectric power station to cost Dh1.4b; Dewa awards contract for Hatta project”, 17 August, <https://gulfnews.com/uae/government/dubai-hydroelectric-power-station-to-cost-dh14b-dewa-awards-contract-for-hatta-project-1.1566032158700>.

Hopf, D. (2020), “Balancing technology: Fengning 2, China”, Andritz, www.andritz.com/hydro-en/hydronews/hn32/fengning2-china.

Hunt, J.D. et al. (2020), “Global resource potential of seasonal pumped hydropower storage for energy and water storage”, *Nature Communications*, Vol. 11, www.nature.com/articles/s41467-020-14555-y.

Hydro-Québec (2010), “Maski: Underwater robot for dam inspections”, Montreal, www.hydroquebec.com/innovation/en/pdf/2010G080-20A-Maski.pdf.

Hydro Review (2019), “Floating solar photovoltaic plant to be installed at Kruonis pumped-storage plant in Lithuania”, 27 February, www.hydroreview.com/2019/02/27/floating-solar-photovoltaic-plant-to-be-installed-at-kruonis-pumped-storage-plant-in-lithuania.

Iannunzio, E. (2018), “Wind farm proposed for Kidston Solar Pumped Hydro project”, *Utility Magazine*, 6 April, <https://utilitymagazine.com.au/wind-farm-proposed-for-kidston-solar-pumped-hydro-project>.

IHA (International Hydropower Association) (2019), “Pumped Storage Tracking Tool”, www.hydropower.org/hydropower-pumped-storage-tool.

IHA (2018), “The world’s water battery: Pumped hydropower storage and the clean energy transition”, www.hydropower.org/publications/the-worlds-water-battery-pumped-hydropower-storage-and-the-clean-energy-transition.

IHA (2017a), *2017 Key Trends in Hydropower*, Briefing, IHA, London, www.hydropower.org/sites/default/files/publications-docs/2017%20Key%20Trends%20in%20Hydropower_0.pdf.

IHA (2017), *Hydropower Status Report 2017*, IHA, London, www.hydropower.org/2017-hydropower-status-report.

IIASA (International Institute for Applied Systems Analysis) (2020), “Seasonal pumped hydropower storage could solve the renewable energy storage challenge”, *SciTechDaily*, 20 February, <https://scitechdaily.com/seasonal-pumped-hydropower-storage-could-solve-the-renewable-energy-storage-challenge>.

IRENA (2019a), *Innovation landscape for a renewable powered-future: Solutions to integrate variable renewables*, International Renewable Energy Agency, Abu Dhabi, www.irena.org/publications/2019/Feb/Innovation-landscape-for-a-renewable-powered-future.

IRENA (2019b), *Global energy transformation: The REmap transition pathway (Background report to 2019 edition)*, International Renewable Energy Agency, Abu Dhabi.

IRENA (2019c), *Innovation landscape brief: Innovative ancillary services*, International Renewable Energy Agency, Abu Dhabi, https://irena.org/-/media/Files/IRENA/Agency/Publication/2019/Feb/IRENA_Innovative_ancillary_services_2019.pdf.

IRENA (2019d), *Innovation landscape brief: Increasing time granularity in electricity markets*, International Renewable Energy Agency, Abu Dhabi, https://irena.org/-/media/Files/IRENA/Agency/Publication/2019/Feb/IRENA_Increasing_time_granularity_2019.pdf.

IRENA (2019e), *Innovation landscape brief: Artificial intelligence and big data*, International Renewable Energy Agency, Abu Dhabi, www.irena.org/publications/2019/Sep/Artificial-Intelligence-and-Big-Data.

- IRENA** (2019f), *Innovation landscape brief: Internet of Things*, International Renewable Energy Agency, Abu Dhabi, www.irena.org/publications/2019/Sep/Internet-of-Things.
- IRENA** (2016). *Renewable energy market analysis: Latin America*, International Renewable Energy Agency, Abu Dhabi, www.irena.org/publications/2016/Nov/Renewable-Energy-Market-Analysis-Latin-America.
- Lazard** (2016), “Lazard’s leveled cost of storage – Version 2.0”, www.lazard.com/media/438042/lazard-levelized-cost-of-storage-v20.pdf.
- Lorinc**, J. (2016), “Innovation in hydro power: How Hydro-Quebec is turning problems into opportunities for innovation”, *Canadian Geographic*, 25 May, www.canadiangeographic.ca/article/innovation-hydro-power.
- LT Daily** (2016). “Nordbalt fault sees emergency Kruonis reserve activated for second time in four days”, Delfi.en, 20 May, <https://en.delfi.lt/politics/nordbalt-fault-sees-emergency-kruonis-reserve-activated-for-second-time-in-four-days.d?id=71319994>.
- Max Bögl** (2018), “Gaildorf pioneers electricity storage”, www.mbrenewables.com/en/pilot-project.
- Nagura**, O. *et al.* (2010), “Hitachi’s adjustable-speed pumped-storage system contributing to prevention of global warming”, *Hitachi Review*, Vol. 59/3, pp. 99–105, www.hitachi.com/rev/pdf/2010/r2010_03_107.pdf.
- Pöyry** (2014), *Pumped Storage Schemes*, Pöyry, Vienna, www.poyry.at/sites/www.poyry.at/files/media/related_material/hydro_power_pumped-storage_brochure_0112014_6.pdf.
- Prouvost**, B. (2017), “Creating the ultimate hybrid system by mixing solar energy and hydroelectricity”, *Renewable Energy Focus*, 27 April, www.renewableenergyfocus.com/view/45793/creating-the-ultimate-hybrid-system-by-mixing-solar-energy-and-hydroelectricity.
- Voith** (2019), “Europe’s most advanced pumped-storage plant”, <http://voith.com/corp-en/industry-solutions/hydropower/pumped-storage-plants/frades-ii-portugal.html>
- Wänn**, A., and P. Leahy (2014), *Energy Storage Action List: Promoting Energy Storage in Ireland*, stoRE Project, European Union, Brussels, www.store-project.eu/documents/target-country-results/en_GB/energy-storage-action-list-in-ireland.
- World Bank Group**, ESMAP and SERIS (2019), *Where Sun Meets Water: Floating Solar Market Report*, World Bank, Washington, DC.
- XFLEX HYDRO** (2019a), “Frades 2 Portugal”, <https://xflexhydro.net/frades-2>.
- XFLEX HYDRO** (2019b), “Z’mutt Switzerland”, <https://xflexhydro.net/zmutt>.
- XFLEX HYDRO** (2019c), “Alqueva Portugal”, <https://xflexhydro.net/alqueva>.
- Zhang**, S., P. Andrews-Speed and P. Perera (2015), “The evolving policy regime for pumped storage hydroelectricity in China: A key support for low-carbon energy”, *Applied Energy*, Vol. 150, Elsevier, Amsterdam, pp. 15–24, www.sciencedirect.com/science/article/abs/pii/S0306261915004055.

INNOVATIVE OPERATION OF PUMPED HYDROPOWER STORAGE INNOVATION LANDSCAPE BRIEF

© IRENA 2020

IRENA HEADQUARTERS

P.O. Box 236, Abu Dhabi
United Arab Emirates

www.irena.org

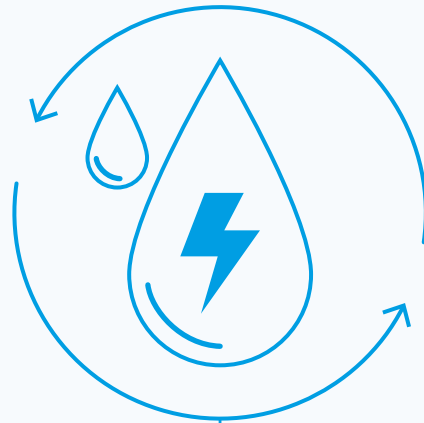

VIRTUAL POWER LINES

INNOVATION LANDSCAPE BRIEF



© IRENA 2020

Unless otherwise stated, material in this publication may be freely used, shared, copied, reproduced, printed and/or stored, provided that appropriate acknowledgement is given of IRENA as the source and copyright holder. Material in this publication that is attributed to third parties may be subject to separate terms of use and restrictions, and appropriate permissions from these third parties may need to be secured before any use of such material.

ISBN 978-92-9260-181-2

Citation: IRENA (2020), *Virtual power lines*, International Renewable Energy Agency, Abu Dhabi.

ABOUT IRENA

The International Renewable Energy Agency (IRENA) is an intergovernmental organisation that supports countries in their transition to a sustainable energy future and serves as the principal platform for international co-operation, a centre of excellence, and a repository of policy, technology, resource and financial knowledge on renewable energy. IRENA promotes the widespread adoption and sustainable use of all forms of renewable energy, including bioenergy, geothermal, hydropower, ocean, solar and wind energy in the pursuit of sustainable development, energy access, energy security and low-carbon economic growth and prosperity. www.irena.org

ACKNOWLEDGEMENTS

This report was prepared by the Innovation team at IRENA's Innovation and Technology Centre (IITC) and was authored by Arina Anisie and Francisco Boshell, with additional contributions and support from Harsh Kanani and Anusha Rajagopalan (KPMG India).

Valuable review was provided by Patrick Clerens (The European Association for Storage of Energy – EASE) and Alexis Cauzit (RTE), along with Harold Anuta, Gayathri Nair, Laura Casado, Elena Ocenic, Nina Litman-Roventa, Martina Lyons and Paul Komor (IRENA).

DISCLAIMER

This publication and the material herein are provided “as is”. All reasonable precautions have been taken by IRENA to verify the reliability of the material in this publication. However, neither IRENA nor any of its officials, agents, data or other third-party content providers provides a warranty of any kind, either expressed or implied, and they accept no responsibility or liability for any consequence of use of the publication or material herein.

The information contained herein does not necessarily represent the views of all Members of IRENA. The mention of specific companies or certain projects or products does not imply that they are endorsed or recommended by IRENA in preference to others of a similar nature that are not mentioned. The designations employed and the presentation of material herein do not imply the expression of any opinion on the part of IRENA concerning the legal status of any region, country, territory, city or area or of its authorities, or concerning the delimitation of frontiers or boundaries.

Photographs are from Shutterstock unless otherwise indicated.

This document does not represent the official position of IRENA on any particular topic. Rather, it is intended as a contribution to technical discussions on the promotion of renewable energy.

1 BENEFITS

Virtual power lines (VPLs) allow large-scale integration of solar and wind power without grid congestion or redispatch, avoiding any immediate need for large grid infrastructure investments.

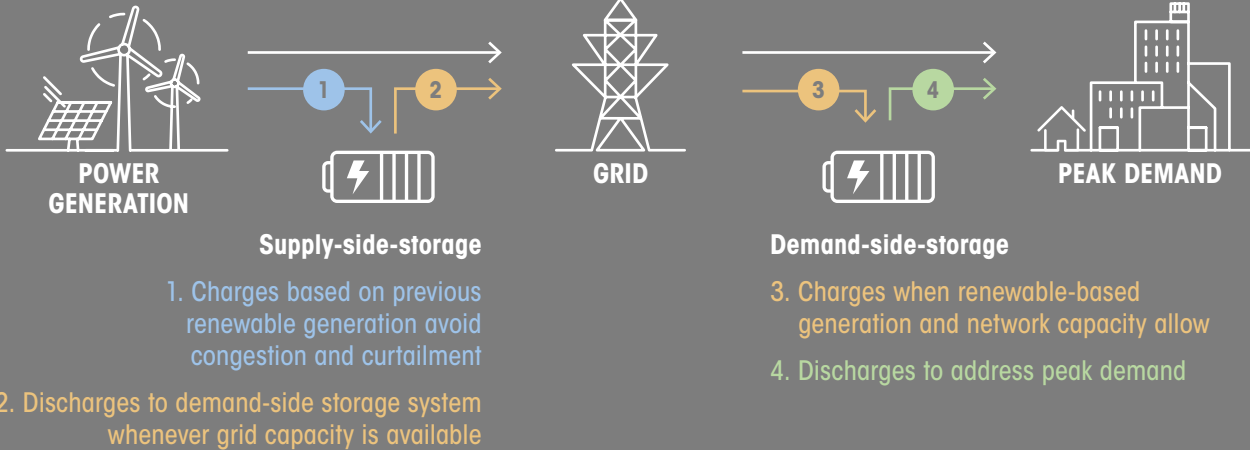

2 KEY ENABLING FACTORS

-  Regulatory framework for energy storage systems
-  Multi-service business case for storage systems
-  Digitalisation

3 SNAPSHOT

- VPLs provide 3 GW of installed storage capacity worldwide
- Global needs for network investment deferral could reach 14.3 GW by 2026.
- Australia, Italy, France and the US are piloting VPLs to reduce renewable power curtailment.

What are VPLs?

VPLs consist of utility-scale storage systems connected to grid at two key points:

- One on the **supply side**, storing surplus generation from renewables that could not be transmitted due to grid congestion.
- Another on the **demand side**, charged whenever grid capacity allows and then discharged when needed.

VIRTUAL POWER LINES

Storage systems used as VPLs complement existing infrastructure and offer a technically sound, financially viable alternative to reinforcing the power grid where additional capacity is needed.

ABOUT THIS BRIEF

This brief forms part of the IRENA project “Innovation landscape for a renewable-powered future”, which maps the relevant innovations, identifies the synergies and formulates solutions for integrating high shares of variable renewable energy (VRE) into power systems.

The synthesis report, “*Innovation landscape for a renewable-powered future: Solutions to integrate variable renewables*” (IRENA, 2019a), illustrates the need for synergies between different

innovations to create actual solutions. Solutions to drive the uptake of solar and wind power span four broad dimensions of innovation: enabling technologies, business models, market design and system operation.

Along with the synthesis report, the project includes a series of briefs, each covering one of 30 key innovations identified across those four dimensions. The 30 innovations are listed in the figure below.

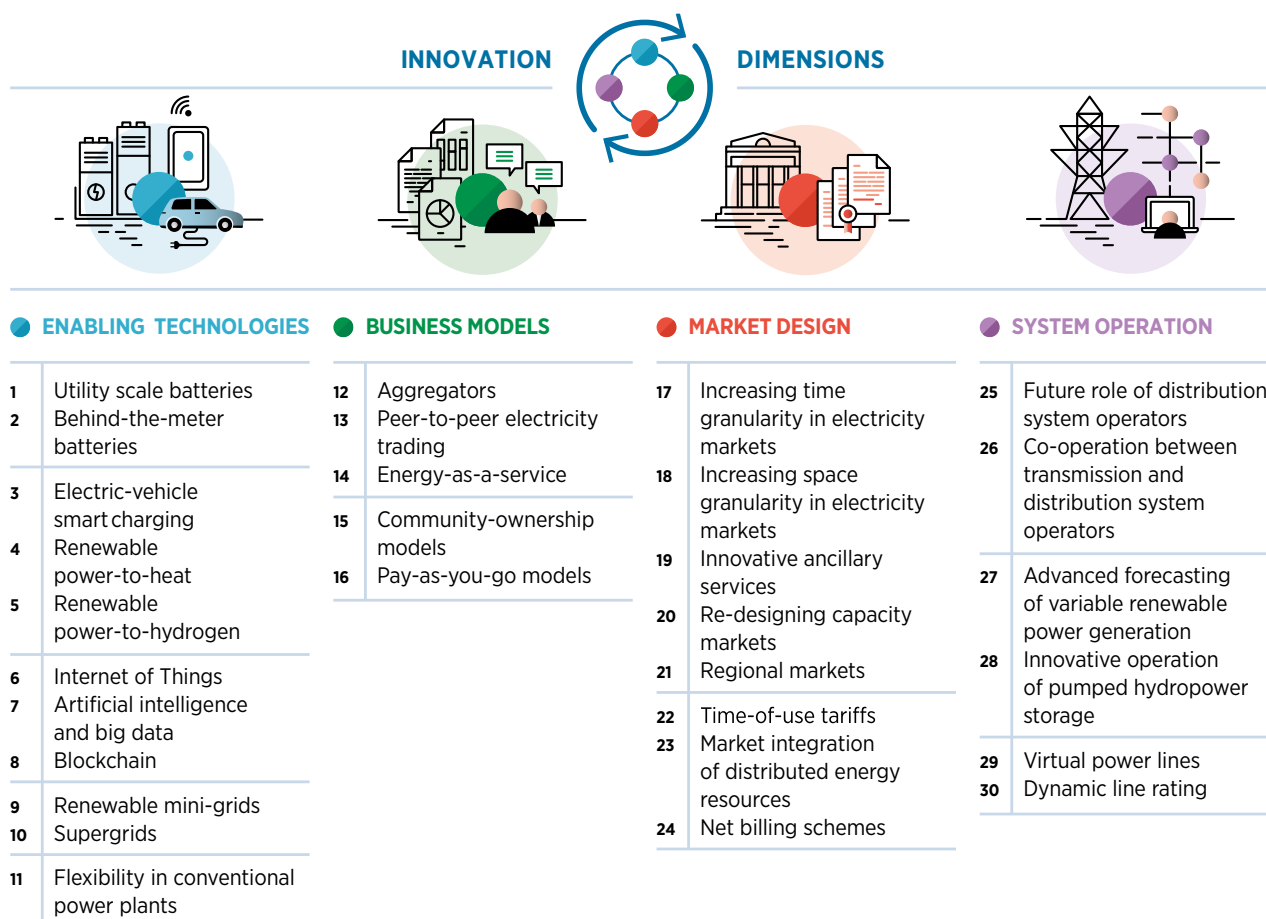

This brief provides an overview of virtual power lines (VPLs)¹ – the innovative operation of energy storage systems (ESSs), particularly utility-scale batteries, in response to the increased integration of renewable energy in capacity-constrained transmission and distribution networks. The brief highlights examples of battery storage systems deployed with the primary objective of deferring conventional grid reinforcement, and explores innovative ways to operate batteries to enable VRE integration in different power system contexts.

The brief is structured as follows:

- I [Description](#)
- II [Contribution to power sector transformation](#)
- III [Key factors to enable deployment](#)
- IV [Current status and examples of ongoing initiatives](#)
- V [Implementation requirements: Checklist](#)



1 Also referred to as virtual transmission lines or non-wire alternatives.

I. DESCRIPTION

The increasing share of renewable electricity in power systems, especially from variable sources, requires efficient management of transmission and distribution networks to prevent congestion. The traditional approach to increasing grid capacity is reinforcing the system with additional network components (e.g. adding overhead lines) or by upgrading existing lines or cables to address thermal or voltage constraints.

As an alternative to expensive upgrades to the transmission and distribution infrastructure for VRE grid integration, non-wire alternatives – also called virtual power lines (VPLs) – are being rolled out. Instead of reinforcing or building additional transmission and distribution systems, energy storage systems (ESSs) connected at certain points of the grid can support the existing network infrastructure and enhance the performance and reliability of the system. VPLs are a particular application of batteries. In this case, batteries are usually owned and operated by system operators (for more information about batteries' applications see *Innovation landscape brief: Utility-scale batteries* [IRENA, 2019b]).

VPLs include ESSs connected in at least two locations. The first is on the supply side, close to the renewable generation source, which stores surplus electricity production that cannot be transmitted due to grid congestion.

Such storage averts the need for curtailment. The other, on the demand-side, can be charged whenever transmission capacity is available. In this second case, the ESS is used to meet demand during periods when there is insufficient transmission capacity, using batteries charged during previous periods of low demand and free transmission capacity.

Ultimately, a VPL is the application of ESSs to help manage congestion without interfering in the balance between demand and supply. Figures 1 and 2 illustrate how VPLs work.

Used as VPLs, utility-scale battery storage offers a technical alternative to adding electricity grid capacity, while also increasing system reliability and security. The aim of using VPLs is to make additional electricity capacity available much faster and, in some cases, at a lower cost than pursuing a conventional infrastructure reinforcement or expansion. VPLs provide a particularly cost-effective solution when network congestion occurs during specific rare events, such as extremely high temperatures during the summer, and when costly upgrades to network capacity would be underutilised. Furthermore, if regulations permit, the ESS can also support the system by providing ancillary services such as frequency regulation, voltage support and spinning reserves.

Figure 1 The concept of VPLs

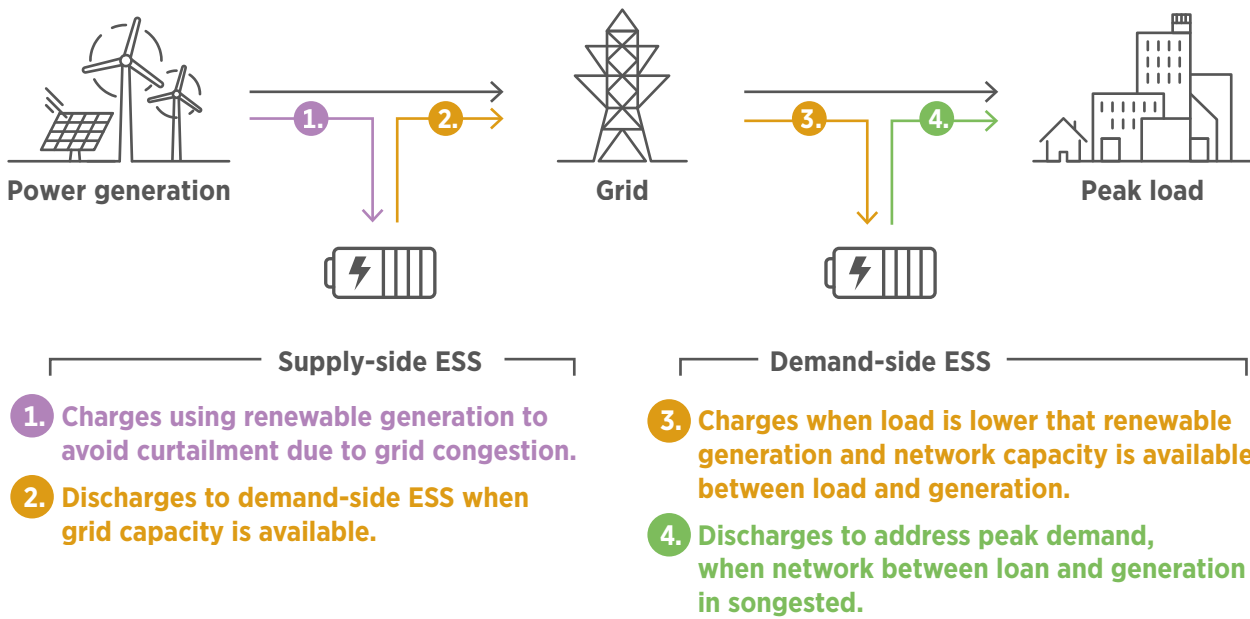
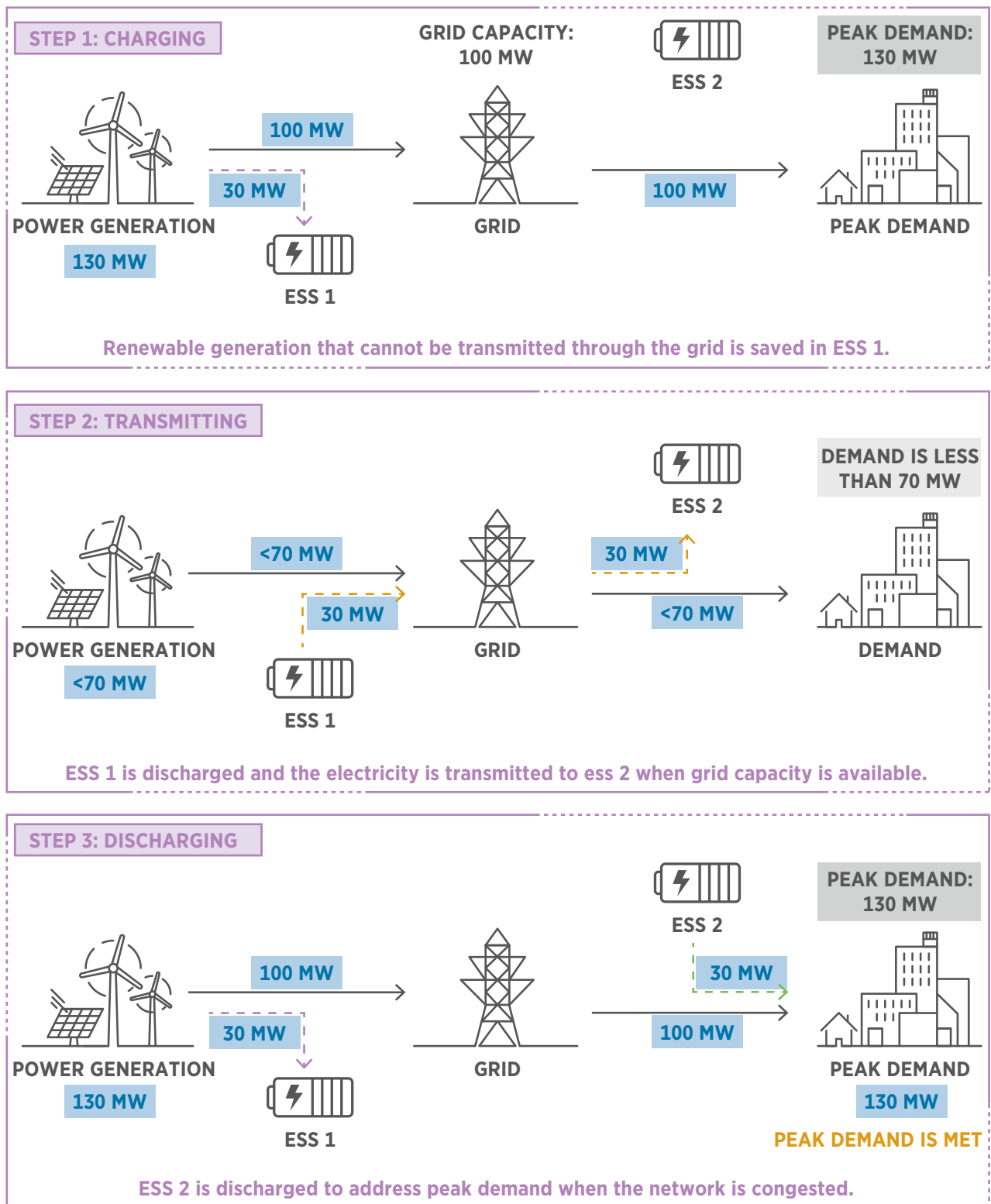

Figure 2 illustrates the flows in a practical example of how a VPL works.

Figure 2 Example of the functioning of a VPL



Note: MW = megawatt.

Source: Adapted from ENTSO-E (2016).

II. CONTRIBUTION TO POWER SECTOR TRANSFORMATION

As mentioned, VPL provides a particularly cost-effective solution when network congestion occurs in specific rare events, such as extremely high temperatures during the summer, and when costly upgrades to network capacity would be underutilised.

In this case, ESSs can enable the integration of higher shares of wind and solar electricity without any need for large capital investments to expand transmission infrastructure. Additionally, with the adoption of necessary regulations, the ESS can provide ancillary services to support the operation of the power system (Figure 3).

Figure 3 Key contributions of VPLs

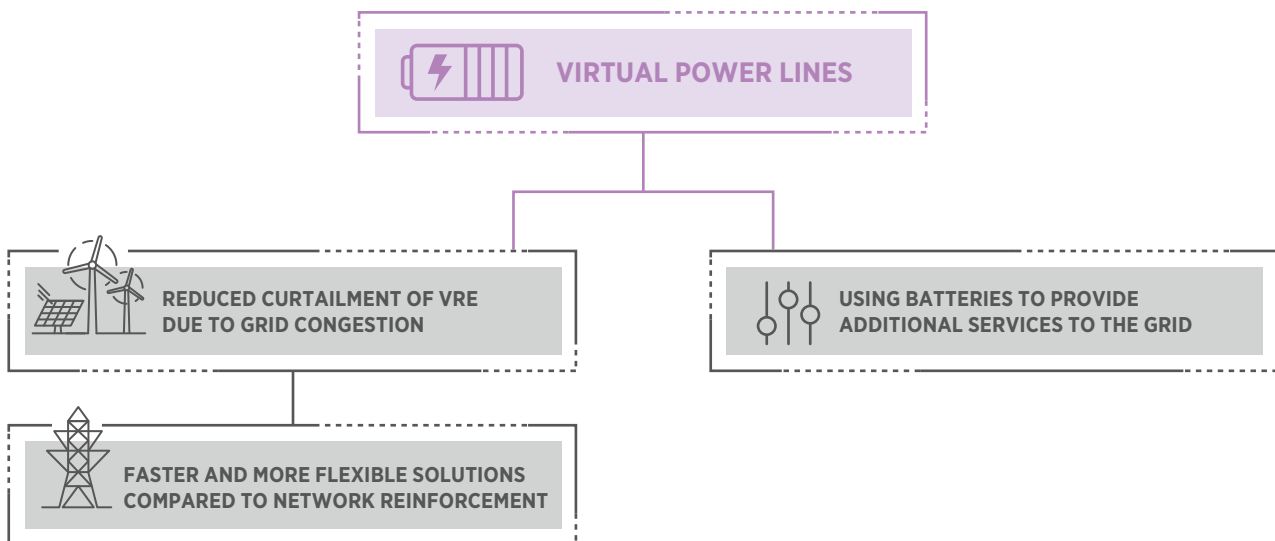

Reduced curtailment of VRE due to grid congestion

Grid congestion tends to happen when network components reach their thermal limits due to excessive generation or demand, or because of a requirement to keep synchronous generation online. Traditional methods adopted to counter it are reinforcing the grid, redispatch, demand response, generation curtailment and other power flow control measures.

Reinforcing the grid is an option that requires significant time to be implemented, may face public acceptance issues and is relatively expensive when congestion happens only rarely. Redispatch refers to shutting down generating units behind the congestion and starting power units beyond the congestion instead, closer to the demand. This option comes at a cost for the system, as actors involved need to be rewarded or compensated. Demand response can be employed to alleviate system congestion by motivating interaction between power system dispatchers and power consumers. However, such an approach presents challenges as it requires both technical and economic considerations.

Curtailment of generation means disconnecting renewables whose generation cannot be controlled. ESSs can be used to absorb the renewable energy generation that would otherwise have been curtailed due to grid congestion. Such batteries must be located at points close to the most frequent congestion points caused by the excess renewable generation.

For example, in Chile the independent power producer AES Gener has submitted a proposal for two 200 MW energy storage projects to the Chilean regulator for inclusion in Chile's National Transmission Expansion Plan. If approved, the two virtual transmission projects will relieve congestion in a transmission line where 700 MW of renewable generation is set to come online (Kumaraswamy, Cabbabe and Wolfschmidt, 2019).

Faster and more flexible solution compared to network reinforcement

The implementation process for traditional investments in transmission upgrades often takes several years and cannot react to rapidly changing demand and generation patterns. Where demand is growing steadily, traditional grid reinforcement investment can be carried out in large increments. This is more difficult in places where demand is flat or declining, such as in Europe, where the need for greater transmission capacity results from the move towards increasing shares of renewable energy and thus changing the location of generation, not higher demand.

Battery storage can provide an immediate solution to congestion on certain lines, especially when congestion occurrences are rare – exceptional events rather than regular ones. With a small amount of storage capacity, the necessary expansion in transmission infrastructure can be deferred up to a point in the future when the cost of the transmission upgrade is lower than the cost of using storage (Eyer, 2009; Eyer and Corey, 2010).

The existing transmission and distribution infrastructure is designed for peak load that only occurs for a limited period. Additional investment to manage variability from increasing VRE could potentially lead to even lower utilisation. Conversely, investing in an ESS will simultaneously result in improved utilisation of both transmission and distribution infrastructure and the VRE generation assets (E2Tech, 2015). Unlike poles and wires, battery-based energy storage is modular and can be scaled to fit the need. Therefore, the storage technology and size most suitable for network needs should be selected to ensure an efficient, reliable and secure operation of the system.

Table 1 summarises the benefits that the VPL can provide as a solution to the need for costly and time-consuming network reinforcement.

Table 1 Summary of network upgrade challenges and benefits brought by VPLs

Network upgrade challenges	Benefits of VPLs
Lengthy (multi-year) planning, permitting and development process	Storage systems can be designed and built, and be operational, in several months to defer transmission upgrades or at least provide resilience for the network through the lengthy development process.
Uncertain load growth rates and demand patterns	VPLs with the ESSs can be deployed in small modular capacity increments, avoiding oversizing and stranded assets.
Single function of transmission capacity	When not needed for transmission and distribution network deferral, ESSs can have multiple uses such as generating revenues and reducing grid operation costs by providing frequency regulation, voltage support, spinning reserves and other services, provided regulations allow them to provide such services.
Local community opposition	The ESSs could have a smaller impact on nearby property values compared to transmission lines, as the ESS are often installed at substations or existing grid facilities.

Source: Eller (2017).

Using batteries to provide additional services to the grid

In addition to enabling greater dispatchability of VRE generation, storage can also provide reactive power, enabling network operators to better preserve system performance in the event of temporary transmission outages or, in more extreme circumstances, prevent blackout. VPL projects are also well-suited to providing a range of ancillary services. Batteries can provide fast frequency response, which could replace peaking gas power plants.

They can also offer system inertia, traditionally provided by coal-fired plants, for which synchronous condensers have become the main requirement, and flexible ramping (see *Innovation landscape brief: Utility-scale batteries* [IRENA, 2019b]).

However, the regulatory framework dictates whether batteries used as VPLs can also participate in the wholesale and ancillary service markets, where such markets exist. Moreover, the optimal use of the battery itself should also consider the number of charges and discharges per day and the life span of the battery.

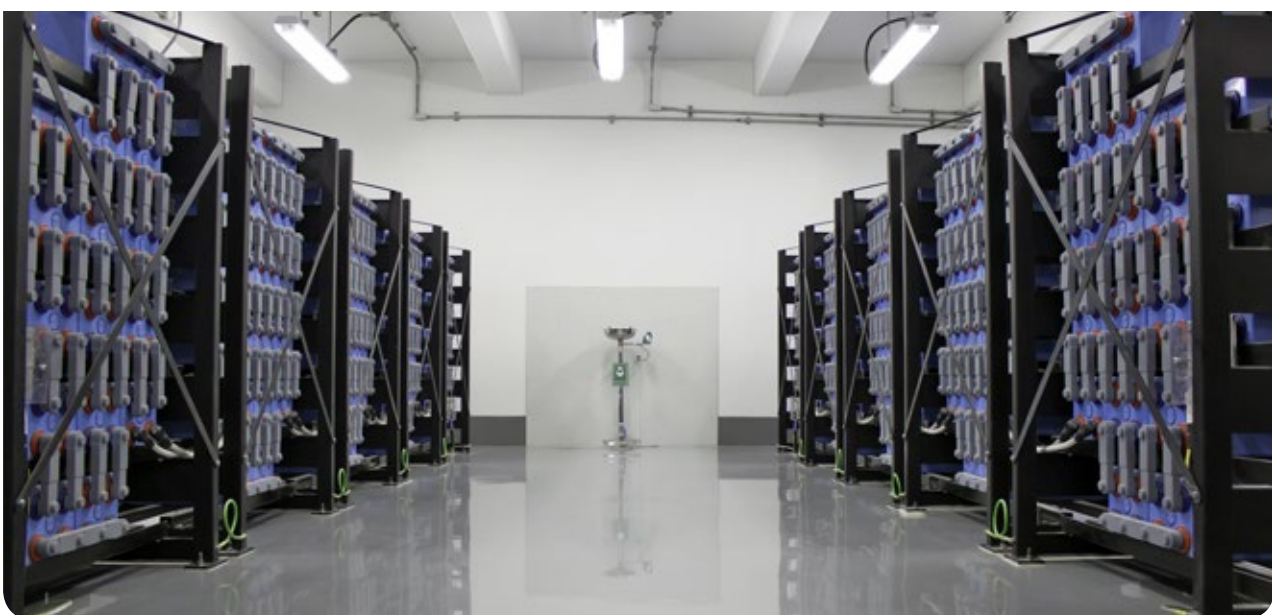

III. KEY FACTORS TO ENABLE DEPLOYMENT

Efficient use of utility-scale battery storage as non-wire reinforcement of network capacity requires regulations that position the battery either as a network asset, as a market player, or both. Communications and control systems are also key for the optimal operation of batteries as VPLs.

Establishing a regulatory framework for ownership and operation of ESSs

Clear regulations regarding the ownership and operation of the ESS are essential for enabling their operation, either as a market participant or as a network asset. For example, if the ESS is classified as a market-based asset, transmission and distribution operators may face restrictions on owning or operating the asset for grid reinforcement deferral. If it is classified as a network asset and used as a VPL, it might not qualify for providing services in a competitive market-based environment.

Therefore, clear regulations are needed to guide the use of ESSs while maximising the benefits for both the system and the ESS. The cost-benefit analysis for storage systems should incorporate benefits offered to the wider power system rather than only considering benefits directly offered to the ESS owner.

Energy storage plays a key role in the transition towards a carbon-neutral economy and has been addressed across different jurisdictions.

The EU “Clean energy for all Europeans” package seeks to define a new regulatory framework that allows energy storage to compete with other flexibility solutions, such as demand response, interconnections, grid upgrades and flexible generation. Directive (EU) 2019/944 on common rules for the internal market for electricity states that network tariffs should be cost-reflective and transparent, while ensuring security of supply and not discriminating against energy storage. As per this directive, generally, distribution and transmission network operators are not allowed to own energy storage assets. However, it provides for certain specific circumstances in which regulated entities, distribution system operators (DSOs) and transmission system operators (TSOs), are allowed to own and operate energy storage facilities (European Commission, 2017). Such situations are:

- If these assets are considered “fully integrated network components”², and the regulatory authority has granted its approval.
- If other parties, following a transparent tendering procedure, have not been awarded the right to own and operate storage or cannot do so at a reasonable cost within the given timeframe.

² Fully integrated network components are those integrated into the transmission or distribution system and are used only for the purpose of reliable operation of the system.

In addition, these facilities must be necessary for DSOs or TSOs to fulfil their obligations, and are not used to buy or sell electricity in electricity markets. In all other situations, energy storage services should be market-based and competitive under the new European electricity market design.

Some TSOs have started naming this solution – using batteries as integrated network components – as VPLs. Certain EU member states have already implemented regulations at national level to enable storage operations as VPLs. In Italy, transmission and distribution network operators are allowed to own and control battery systems if the operator can prove the monetary benefit of energy storage over other alternatives, including the cost of investing in expanding network infrastructure. However, storage systems should not negatively impact competitive market functioning (Castagneto-Gissey and Dodds, 2016). Such regulations enabled Italy's TSO, Terna, to launch projects using grid-connected battery ESSs to integrate renewables and boost transmission capacity.

Outside Europe, countries are also investigating ways to redesign their regulations to enable energy storage as a transmission asset. In September 2019 Australia's Energy Security Board (ESB) called for submissions to inform the redesign of the rules governing the national electricity market. The rules must incentivise storage and other dispatchable generation in the future renewables powered system. The ESB aims to set new rules by 2022 and for them to be implemented by 2025 (PV magazine, 2019).

In the United States, the Federal Energy Regulatory Commission (FERC) Order 841 directs grid operators across the country to develop market rules for energy storage to participate in the wholesale energy, ancillary services and capacity markets by treating storage as a generation resource.

FERC organised a technical workshop stakeholders in November 2019 to explore ways to address challenges and support the deployment of grid-enhancing technologies, including energy storage as a transmission asset. FERC is currently reviewing all the inputs from the workshop, with a view to issuing its position (FERC, 2019; Konidena, 2019).

Implementing the multi-service business case

In a multi-service business case approach, multiple stakeholders are jointly involved in the ownership, development, management and/or operation of a VPL with two or more ESSs to maximise its social welfare by fully deploying all the services the storage system can deliver. This approach reflects the ownership provisions laid out in Articles 36 and 54 of the Directive (EU) 2019/944 on common rules for the internal market for electricity in European Union.

ESSs should be permitted to provide a range of services including storage to reduce congestion, which would help to defer network investment, as well as ancillary and balancing services, such as frequency and voltage regulation. Allowing the stacking of multiple revenues is key to improving the business case for storage and maximising its social welfare. If considered individually, most of the services provided by energy storage facilities do not continuously mobilise 100% of the power/energy capacities of an ESS or do not generate enough revenue to reach profitability (EASE, 2019). This is illustrated in the UK case in Figure 4.

Figure 4 Annual cost-benefit of storage applications in the United Kingdom

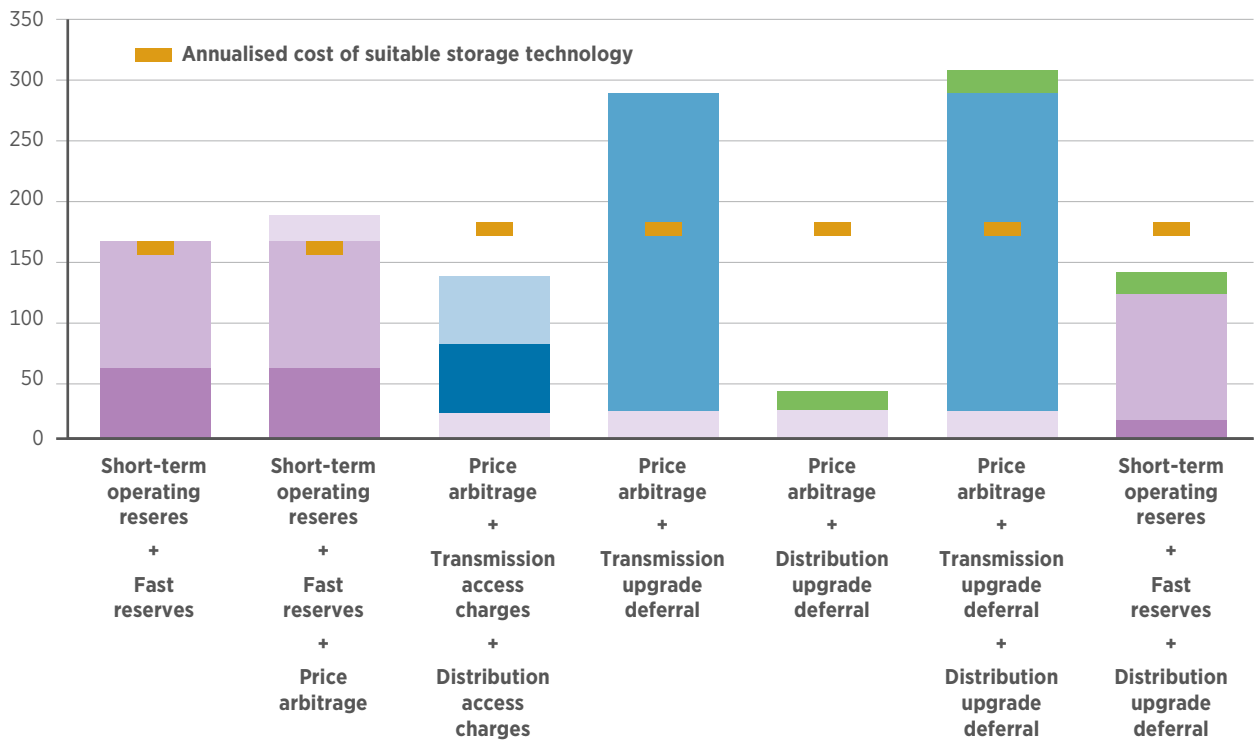

Source: EASE (2019).

Where unbundling rules do not permit TSOs and DSOs to own and operate energy storage assets, market players may be able to operate such assets and thereby participate in balancing and ancillary services markets to maximise storage utilisation. A “hybrid” model could be envisaged where storage assets are developed, owned, operated and maintained by a regulated entity. The regulated entity would dispatch the storage asset for infrastructure services while pursuing its primary goal of ensuring a safe and reliable electricity system.

A market player could be responsible for providing and monetising market-based value streams, such as arbitrage and frequency regulation. If the asset is not used for infrastructure purposes, it could be used to provide market-based services to avoid the suboptimal utilisation of the asset, maximise social welfare and reduce costs for consumers. The revenues the regulated owner would receive from the market players would be deducted from the amount that the regulated entity may include in its cost base (EASE, 2019).

Digitalisation

Digitalisation is critical to employing an ESS effectively as VPL. Communication systems need to be deployed together with energy management software, possibly with artificial intelligence. Digital technologies, such as artificial intelligence, can be used to better predict and make decisions on the management of the ESS. In the case of a multi-service business case, communication between various players involved in the operation of the ESS is key (for more details see the *Innovation landscape brief: Artificial intelligence and big data* [IRENA, 2019b]).

Identifying and agreeing upon the most important interoperability standards will allow for a seamless and secure connection between batteries and system operators. Interoperability standardisation would mark an important step towards the integration of battery storage for energy services and harness the full potential of a flexible, reliable electrical grid system (Dodge-Lamm, 2018).

IV. CURRENT CONTEXT AND ONGOING INITIATIVES

Over the years, the price of grid-connected battery storage has steadily declined and is expected to decline even further in the coming years. For instance, the price of lithium-ion batteries has fallen by over 30% in the past five years (Bullard, 2018). This has made it an affordable non-wire alternative to large capital investments in transmission and distribution network infrastructure.

French TSO, RTE, is implementing its first 40 MW VPL pilot project named RINGO, with the goal of increasing grid integration of renewable energy and optimising electricity currents on its network. A German grid development plan, produced by all four TSOs in the country, has proposed 1.3 gigawatts (GW) of energy storage to ensure grid stability and lower network costs.

The Andhra Pradesh Transmission Company, a publicly owned utility in India, proposed between 250 MW and 500 MW of energy storage to add capacity to its transmission network with an innovative cost recovery mechanism.

The plan, put forth in early 2019, includes allocating costs between renewable power developers and distribution companies that have an obligation to serve load.

In the United States, Pacific Gas & Electric selected a 10 MW energy storage project as part of a portfolio of transmission solutions during its regional transmission planning process, the first such project chosen to provide congestion relief in US markets. In addition, in 2018 the US PJM Interconnection market received proposals for multiple 25–50 MW battery-based storage projects to help relieve network congestion issues (Kumaraswamy, 2019). In Australia, projects using battery-based storage as virtual transmission are being considered alongside traditional poles and wires to add capacity on key interstate transmission lines (Kumaraswamy, Cabbabe and Wolfschmidt, 2019).

Some of the key indicators suggesting the growing use of ESSs for deferring investment in network infrastructure are shown in Table 2.

Table 2 Key indicators about VPLs

Description	Key facts
Countries where VPL projects are being piloted	Australia, France, Germany, India, Italy, United States ¹
Storage capacity of VPL projects currently being considered or constructed (as of 2019)²	Globally: 3 GW US: 62.5–87.5 MW (3 projects) France: 40 MW India: 250–500 MW Chile: 400 MW Germany: 1 300 MW Australia: > 1 000 MW Italy³: 35 MW
Expected growth in battery storage for transmission and distribution investment deferral	~ 14 300 MW by 2026 ⁴
Estimated savings from transmission and distribution investment deferral	USD 100 million project deferred by five years would result in savings of about USD 29 million (assuming discount rate of 7%)

Sources: ¹Kumaraswamy (2019); ²Kumaraswamy, Cabbabe and Wolfschmidt (2019); ³Musio (2017); ⁴Navigant Research (2017).

Examples of VPL projects

RINGO project, France

The French TSO, RTE, has deployed a pilot project called RINGO that involves placing ESSs at three various locations in the network to manage congestion. The ESSs will be deployed so that while one battery absorbs renewable energy generation in excess of transmission capacity, another will be connected to the demand centre. Each battery in this system will have a capacity of 12 MW/24 megawatt hours (MWh) and is expected to be operational in 2020, for a test period of three years. The batteries used will be lithium-metal-polymer batteries at one location, and lithium-ion batteries at the other two locations.

Control systems will determine when the energy stored in the supply side battery can be shifted to the demand side battery according to the transmission line congestions, generation and demand patterns. The aim of this battery system is to help manage congestions without interfering in the balance between demand and supply (Energy Storage News, 2018).

From 2020 to 2023, the batteries will be operated solely by RTE as VPLs. From the beginning of 2023, they will be open for use by third parties for potentially multiple uses such as frequency regulation, demand and supply adjustment, congestion resolution and energy arbitrage, among others (Pie, 2018).

This pilot project was authorised by the French Energy Regulatory Commission (CRE) for a period of three years as an experiment to capture lessons learned, also called a “regulatory sandbox” environment. The regulator has approved a budget of EUR 80 million (about USD 95 million) for this project.

Multi-use of energy storage systems, Italy

The rapid integration of VRE into the grid in Italy has not allowed enough time to strengthen and expand the transmission and distribution network. In response to the resulting grid congestion, about 500 gigawatt hours of wind energy was curtailed in 2010. To address the issue, Terna, Italy’s TSO, has implemented pilot projects to test the use of battery storage systems to reduce VRE curtailment and solve grid congestion.

As part of a pilot project, Terna installed three grid-scale sodium sulphur (NaS) batteries with a total capacity of 34.8 MW/250 MWh in the Campania region. The aim was for the batteries to store wind energy that would otherwise have been curtailed due to transmission congestion. The stored energy was then transported to northern parts of the country whenever transmission lines are not congested (NGK, 2019). These batteries were also used to provide ancillary services to the grid, such as primary and secondary frequency regulation (Musio, 2017).³ The net efficiency of the battery systems was found to be 65-80% in continuous operation, providing both primary and secondary frequency regulation services (Musio, 2017).

³ The Terna example followed specific rules in Italy that limit pilot projects to a specified duration.

MurrayLink 2.0, Victoria to South Australia, Australia

Lyon Group's large-scale solar and battery storage projects in Riverland and Nowingi, Australia, have created a new virtual grid, providing the option to defer or reduce investment in grid reinforcements. The project provides a combined 180 MW/720 MWh of advanced battery storage, located on either side of the existing 220 MW MurrayLink interconnector, and acts as a VPL providing 15% additional transmission capacity. It allows congestion management to unlock inter-regional Renewable Energy Zones and enables greater utilisation of the interconnector asset.

Australia's first VPL provided the option of lifting transmission constraints ten times faster than the time required to construct a new interconnector and at a fraction of the cost, resulting in reduced electricity prices, and providing long-duration storage to firm renewable generation and fast frequency response to the system (Lyon Group, 2019).



Grid booster project, Germany

A key challenge in the German energy transition is the adaptation of its grid infrastructure to an increasing share of renewables, especially wind and solar. A number of highly energy-intensive industries are located in southern Germany, and as nuclear plants are phased out in the southern states, increasing amounts of electricity need to be transferred from the north to the south of the country. This results in increasing congestion along the north-south transmission line. Reinforcing the grid is a very lengthy process that poses various challenges, including potential impacts on the environment and land acquisition difficulties.

In addition to reinforcing the grid, the German regulator plans to avoid grid congestion via greater digitisation and the use of new technologies. Two innovative pilot facilities for grid boosters under the Network Development Plan were approved at the end of December 2019 (Federal Ministry of Economic Affairs and Energy, 2020). Specifically, two spatially separated energy storage devices are planned to be installed to the north and south of the main grid congestion, to act as source and sink, and thus a VPL, in case of emergency (Tennet, 2020).



V. IMPLEMENTATION REQUIREMENTS: CHECKLIST

<p>TECHNICAL REQUIREMENTS</p> 	<ul style="list-style-type: none"> • Batteries or other ESSs (such as thermal storage systems) with the ability to effectively meet transmission and distribution network requirements. The ESS should be chosen according to the time duration/scale of the congestion, as well as the technical capabilities of the storage to provide the necessary services (batteries being more effective at providing synthetic inertia than thermal storage). • Control systems to optimise the utilisation of battery and network infrastructure (possibly using artificial intelligence). • Common interoperable standards (both at the physical and the information communication technology layers) to increase co-ordination between the ESS and the system and network operators.
<p>REGULATORY REQUIREMENTS</p> 	<ul style="list-style-type: none"> • Clear rules on the ownership and operation of the VPL. • Compensation structures that reflect the costs of the VPL. • Regulations enabling a multi-service business case, so that the social welfare benefits provided by the ESS is maximised. • Regulations that enable network operators to consider battery storage systems in network planning, together with conventional investments in network infrastructure.
<p>STAKEHOLDER ROLES AND RESPONSIBILITIES</p> 	<p>System operators</p> <ul style="list-style-type: none"> • Invest more in pilot projects to evaluate the benefits of VPLs with ESS over conventional network infrastructure. • Consider batteries and storage solutions in the grid planning process. • Include in their operational practices the use of batteries to alleviate congestion.

ABBREVIATIONS

CRE	Energy Regulatory Commission	MW	Megawatt
DSO	Distribution system operator	MWh	Megawatt hour
ESB	Energy Security Board	TSO	Transmission System Operator
ESS	Energy Storage System	VPL	Virtual Power Line
FERC	Federal Energy Regulatory Commission	VRE	Variable Renewable Energy
GW	Gigawatt		

BIBLIOGRAPHY

Bullard, N. (2018), “Approaches for using scenarios in strategic decision making”, Bloomberg New Energy Finance.

Dodge-Lamm, C. (2018), “Challenge #1: Interoperability”, Fifthvolt, <https://fifthvolt.com/2018/07/03/challenge-1-interoperability/>.

EASE (2019), “EASE position paper on maximising social welfare of energy storage facilities through multi-service business cases”, European Association for Storage of Energy, http://ease-storage.eu/wp-content/uploads/2019/04/2019.04_Multi-Service-Business-Models_Position-Paper.pdf.

E2Tech (2015), “Energy storage as an emerging tool for utilities to resolve grid constraints”, presentation on 18 June 2015, www.e2tech.org/Resources/Documents/Rittershausen_Convergent_E2Tech_6-18-15_FINAL.pdf.

Eller, A. (2017), “Energy storage will disrupt transmission and distribution investments”, www.utilitydive.com/news/energy-storage-will-disrupt-transmission-and-distribution-investments/506945/.

Energy Storage News (2018), “French utility RTE’S RINGO (‘Virtual Power Line’) will come online in 2020”, <https://energystorageforum.com/news/energy-storage/french-utility-rtes-ringo-virtual-power-line-will-come-online-in-2020>.

ENTSO-E (2016), “Energy storage and storage devices”, European Network of Transmission System Operators for Electricity.

European Commission (2017), “Directive of the European Parliament and of the council on common rules for the internal market in electricity”, https://ec.europa.eu/energy/sites/ener/files/documents/1_en_act_part1_v7_864.pdf.

Eyer, J. (2009), “Electric Utility transmission and distribution upgrade deferral benefits from modular electric storage”, Sandia National Laboratories, <https://prod-ng.sandia.gov/techlib-noauth/access-control.cgi/2009/094070.pdf>.

Eyer, J. and G. Corey (2010), “Energy storage for the electricity grid: Benefits and market potential assessment guide”, Sandia National Laboratories.

Kumaraswamy, K., J. Cabbabe and H. Wolfschmidt (2019), “Redrawing the network map: energy storage as virtual transmission”, white paper, Fluence.

Federal Ministry of Economic Affairs and Energy (2020), “What is a grid booster?”, www.bmwi-energiewende.de/EWD/Redaktion/EN/Newsletter/2020/02/Meldung/direkt-account.html.

FERC (2019), “Grid-enhancing technologies”, Docket No. AD19-19-000, Notice of workshop (September 9, 2019), www.ferc.gov/CalendarFiles/20190909124543-AD19-19-000%20WS.pdf.

Castagneto-Gissey, G. and P. E. Dodds (2016), “Regulatory challenges to energy storage deployment: An overview of the UK market”, UCL Energy Institute, www.restless.org.uk/documents/working-paper-1.pdf.

IRENA (2019a), “Innovation landscape for a renewable-powered future: Solutions to integrate variable renewables”, International Renewable Energy Agency, Abu Dhabi.

IRENA (2019b), “Innovation landscape brief: Utility-scale batteries”, International Renewable Energy Agency, Abu Dhabi.

Lyon Group (2019), “Australia’s first Virtual Transmission Line: Victoria – South Australia”, www.lyonasia.com.au/blog/australias-first-virtual-transmission-line-victoria-south-australia/.

Konidena, R. (2019), “FERC Order 841 levels the playing field for energy storage”, MRS Energy & Sustainability, Vol. 6, E5, www.cambridge.org/core/services/aop-cambridge-core/content/view/44929D1C70B34E339B60C59EC32872CB/S2329222919000059a.pdf/ferc_order_841_levels_the_playing_field_for_energy_storage.pdf.

Kumaraswamy, K. (2019), “Why networks think battery storage may be smarter choice than more poles and wires”, Renew Economy, <https://reneweconomy.com.au/why-networks-think-battery-storage-may-be-smarter-choice-than-more-poles-and-wires-16241/>.

PV magazine (2019), “If not transmission.. then batteries?”, PV magazine, page 68–71, www.pv-magazine.com/magazine-archive/if-not-transmission-then-batteries/.

Musio, M. (2017), “Terna’s grid-scale battery storage projects”, www.etip-snet.eu/wp-content/uploads/2017/06/2.-Storage-Lab-Project-Maura-Musio.pdf.

Navigant Research (2017), “Energy storage for transmission and distribution deferral”, www.navigantresearch.com/reports/energy-storage-for-transmission-and-distribution-deferral.

NGK (2019), “NAS Battery”, https://jcpage.jp/tec/jc-2/pdf/63_28_J.pdf.

Pie, Jean-Philippe (2018), “La ligne virtuelle Ringo entrera en scène en 2020 chez RTE”, www.greenunivers.com/2018/02/ligne-virtuelle-ringo-entrera-scene-2020-chez-rte-176704/.

Tennet (2020), “Grid booster”, www.tennet.eu/fileadmin/user_upload/Company/Our_Responsibility/CSR_2018/13618007_TenneT_AR18_Grid_booster.pdf.

VIRTUAL POWER LINES

INNOVATION LANDSCAPE BRIEF

© IRENA 2020

IRENA HEADQUARTERS
P.O. Box 236, Abu Dhabi
United Arab Emirates

www.irena.org



DYNAMIC LINE RATING

INNOVATION LANDSCAPE BRIEF



© IRENA 2020

Unless otherwise stated, material in this publication may be freely used, shared, copied, reproduced, printed and/or stored, provided that appropriate acknowledgement is given of IRENA as the source and copyright holder. Material in this publication that is attributed to third parties may be subject to separate terms of use and restrictions, and appropriate permissions from these third parties may need to be secured before any use of such material.

ISBN 978-92-9260-182-9

Citation: IRENA (2020), *Innovation landscape brief: Dynamic line rating*, International Renewable Energy Agency, Abu Dhabi.

ABOUT IRENA

The International Renewable Energy Agency (IRENA) is an intergovernmental organisation that supports countries in their transition to a sustainable energy future and serves as the principal platform for international co-operation, a centre of excellence, and a repository of policy, technology, resource and financial knowledge on renewable energy. IRENA promotes the widespread adoption and sustainable use of all forms of renewable energy, including bioenergy, geothermal, hydropower, ocean, solar and wind energy in the pursuit of sustainable development, energy access, energy security and low-carbon economic growth and prosperity. www.irena.org

ACKNOWLEDGEMENTS

This report was prepared by the Innovation team at IRENA's Innovation and Technology Centre (IITC) and was authored by Arina Anisie and Francisco Boshell, with additional contributions and support from Shikhin Mehrotra (KPMG India).

Valuable review was provided by Jean-Luis Repetto (Ampacimon), Andrea Michiorri (Mines ParisTech University), along with Harold Anuta, Gayathri Nair, Laura Casado, Elena Ocenic, Nina Litman-Roventa, Martina Lyons and Paul Komor (IRENA).

DISCLAIMER

This publication and the material herein are provided "as is". All reasonable precautions have been taken by IRENA to verify the reliability of the material in this publication. However, neither IRENA nor any of its officials, agents, data or other third-party content providers provides a warranty of any kind, either expressed or implied, and they accept no responsibility or liability for any consequence of use of the publication or material herein.

The information contained herein does not necessarily represent the views of all Members of IRENA. The mention of specific companies or certain projects or products does not imply that they are endorsed or recommended by IRENA in preference to others of a similar nature that are not mentioned. The designations employed and the presentation of material herein do not imply the expression of any opinion on the part of IRENA concerning the legal status of any region, country, territory, city or area or of its authorities, or concerning the delimitation of frontiers or boundaries.

Photographs are from Shutterstock unless otherwise indicated.

This document does not represent the official position of IRENA on any particular topic. Rather, it is intended as a contribution to technical discussions on the promotion of renewable energy.

1 BENEFITS

Dynamic line rating (DLR) reduces congestion on power lines, optimises asset utilisation, improves efficiency and reduces costs. This permits increased solar and wind integration, reduces curtailment for these variable renewable energy (VRE) sources and makes power generation dispatch more cost-effective.

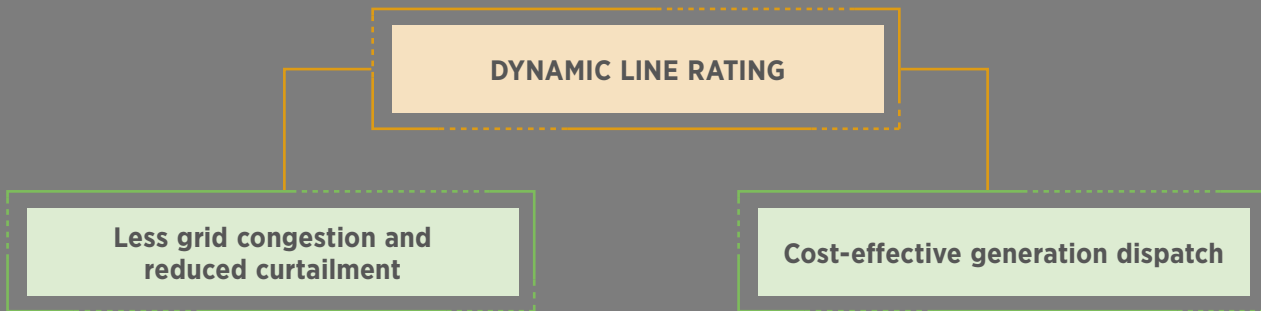

2 KEY ENABLING FACTORS



Algorithms to calculate ampacity



Digitalisation for real-time monitoring, communication and control



Regulatory incentives for cost-efficient grid operation

3 SNAPSHOT

- Oncor Electric Delivery, a US utility, implemented DLR and observed ampacity increases of 6–14% for 84–91% of the time.
- Several transmission system operators in Europe, including Amprion (Germany), Terna (Italy), RTE (France) and Elia (Belgium), are implementing DLR.

WHAT IS DYNAMIC LINE RATING?

DLR refers to the active varying of presumed thermal capacity for overhead power lines in response to environmental and weather conditions. This is done continually in real time, based on changes in ambient temperature, solar irradiation, wind speed and wind direction, with the aim of minimising grid congestion.

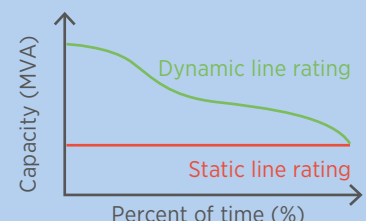

DYNAMIC LINE RATING

Dynamic line rating (DLR) enables the better use of the existing grid, allowing maximised VRE integration by taking advantage of shifting weather conditions and their effects on a power line's thermal capacity.

ABOUT THIS BRIEF

This brief forms part of the IRENA project “Innovation landscape for a renewable-powered future”, which maps the relevant innovations, identifies the synergies and formulates solutions for integrating high shares of variable renewable energy (VRE) into power systems.

The synthesis report, “*Innovation landscape for a renewable-powered future: Solutions to integrate variable renewables*” (IRENA, 2019a), illustrates the need for synergies between different

innovations to create actual solutions. Solutions to drive the uptake of solar and wind power span four broad dimensions of innovation: enabling technologies, business models, market design and system operation.

Along with the synthesis report, the project includes a series of briefs, each covering one of 30 key innovations identified across those four dimensions. The 30 innovations are listed in the figure below.

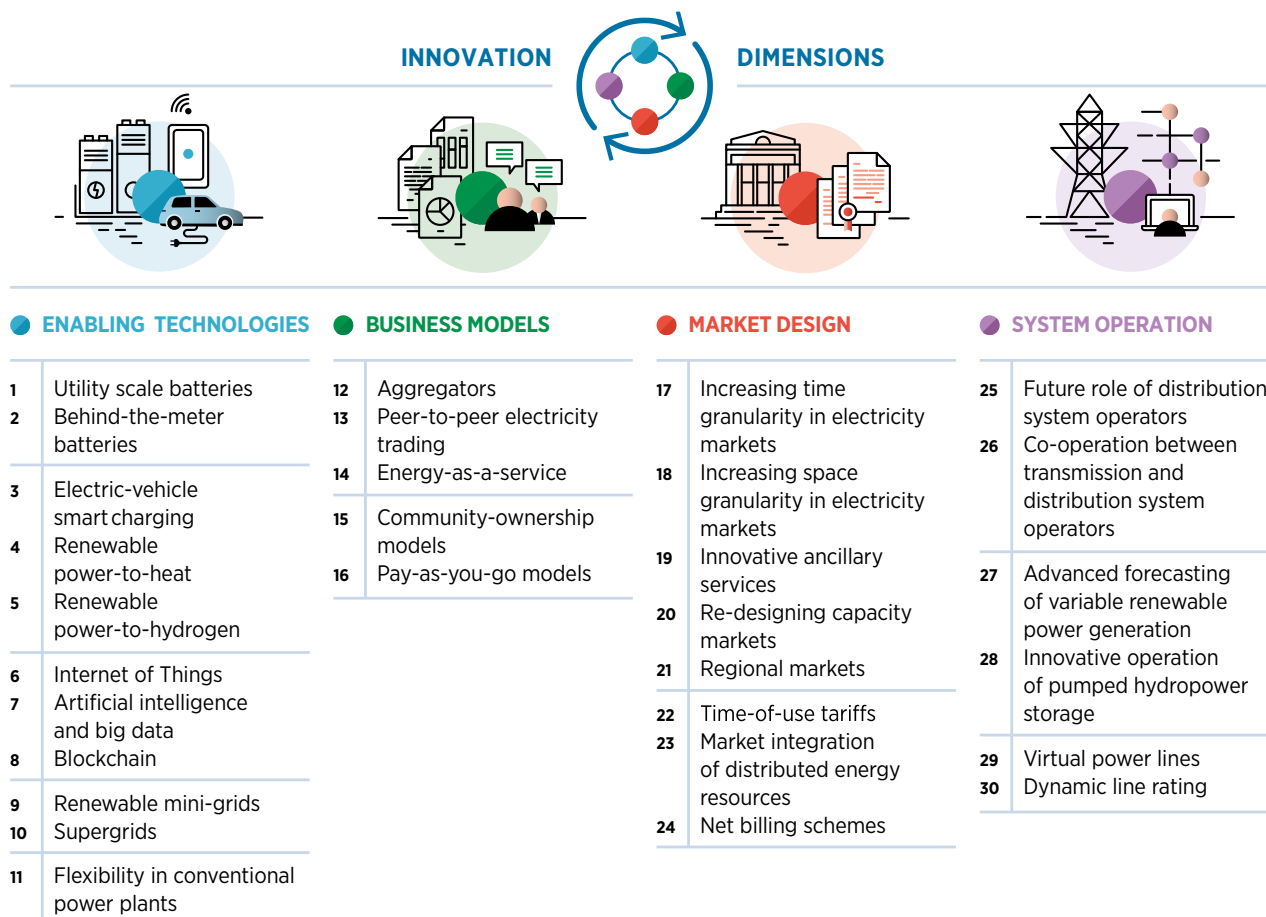

This brief examines a crucial system operation innovation known as dynamic line rating (DLR), which has become increasingly relevant with higher shares of VRE sources in the power system. DLR seeks to increase the ampacity (i.e. the rating) of transmission lines, thus mitigating grid congestion and facilitating the integration of VRE (i.e. wind and solar energy). The concept of DLR is presented and illustrated using different case studies, demonstrating the economic and technical benefits it provides to numerous stakeholders, including utilities, power system operators and VRE plant owners.

The brief is structured as follows:

- I [Description](#)
- II [Contribution to power sector transformation](#)
- III [Key factors to enable deployment](#)
- IV [Current status and examples of ongoing initiatives](#)
- V [Implementation requirements: Checklist](#)



I. DESCRIPTION

Grid congestion occurs when network components reach their thermal limits due to large electricity flows. DLR is the ability to vary the thermal capacity of an overhead transmission or distribution power line (cable) dynamically in real time, depending on the varying environmental conditions (ambient temperature, solar radiation, and wind speed and direction). The aim is to maximise loading at every point in time. Both heating and cooling of the overhead line can affect its thermal capacity with a downward and upward variation in capacity, respectively. A line’s thermal capacity will be higher, for example, when it is cooled by wind or when the temperature drops, allowing more electricity to flow through the line.

Power conductors, such as overhead lines, can carry only a specific amount of current (i.e. the maximum current rating or ampacity) at a given temperature. Passing more current through the conductor leads to overheating of the cables, which results in high levels of power loss. Other factors that influence the ampacity are the sag¹ and tension of the line, the insulation and the physical and electrical properties of the conductor.

Traditionally, system operators have used “static thermal ratings” for transmission and distribution conductors based on expected local extreme meteorological conditions to calculate their theoretical, rather than actual, ampacity. However, the ampacity of a conductor is constantly changing and depends on various factors. Figure 1 lists several factors that affect the ampacity of a transmission cable.

Figure 1 Factors affecting the ampacity of a conductor

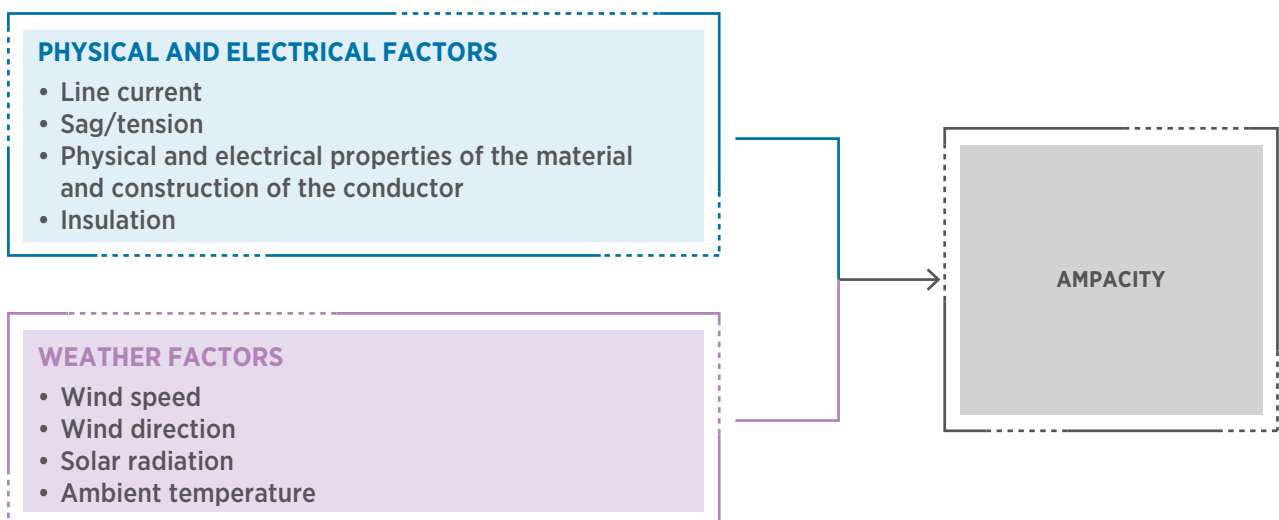

¹ Sag is the difference in level between the points of support and the lowest point of a conductor. Lower sag means a tight conductor and higher tension, whilst higher sag means a loose conductor and lower tension.

Static thermal ratings fail to take into account the variation in the ampacity of a transmission or distribution line due to changes in ambient weather conditions (such as wind speed, wind direction, solar radiation or ambient temperature). DLR systems have the capacity to use sensor-based monitoring and offer the possibility to estimate the ampacity of a transmission line on a real-time basis by observing the ambient weather conditions.

Although DLR systems have been available since the 1990s (mainly explored in France and Belgium), their use has not been widespread due to low levels of correlation between times of high electricity demand and generation (i.e. an increase in power flow through cables or lines) and the availability of higher grid capacity (i.e. instances with high ampacity). Moreover, transmission capacity is generally oversized as the design of transmission lines has been predominantly based on the highest expected power flow.

Due to the rapid deployment of VRE causing increased renewables infeed and decreasing infeed from conventional power plants, power flows in the existing grid infrastructure are changing. Changes in infeed and offtake characteristics cause new peak power flows that have not been recorded before on transmission routes.

To adapt to these shifting conditions caused by the decarbonisation of power generation fleets, DLR can promote better use of existing grid infrastructure whilst integrating larger shares of VRE.

There is, for instance, a strong business case for DLR on lines transporting wind energy thanks to the high correlation of wind power infeed with DLR benefits, with increased ampacity due to the cooling effects of wind. When locations with high wind resources are far from the demand centres, line loading increases to the point where traditional grid operation procedures need to be changed to ensure grid security. However, the presence of winds can reduce the temperature of cables through convective effects (also called concurrent cooling). Such conditions have been estimated to increase the ampacity of close transmission cables by between approximately 100% and 200% (Goodwin *et al.*, 2014; Zeiselmair and Samweber, 2016).

Figure 2 illustrates how the capacity of a transmission line can vary depending on weather conditions. The static ratings generally assume the worst-case weather conditions, using lower limits of capacity in order to maintain adequate security conditions in any situation.



Figure 2 Schematic comparison of static and dynamic current limit

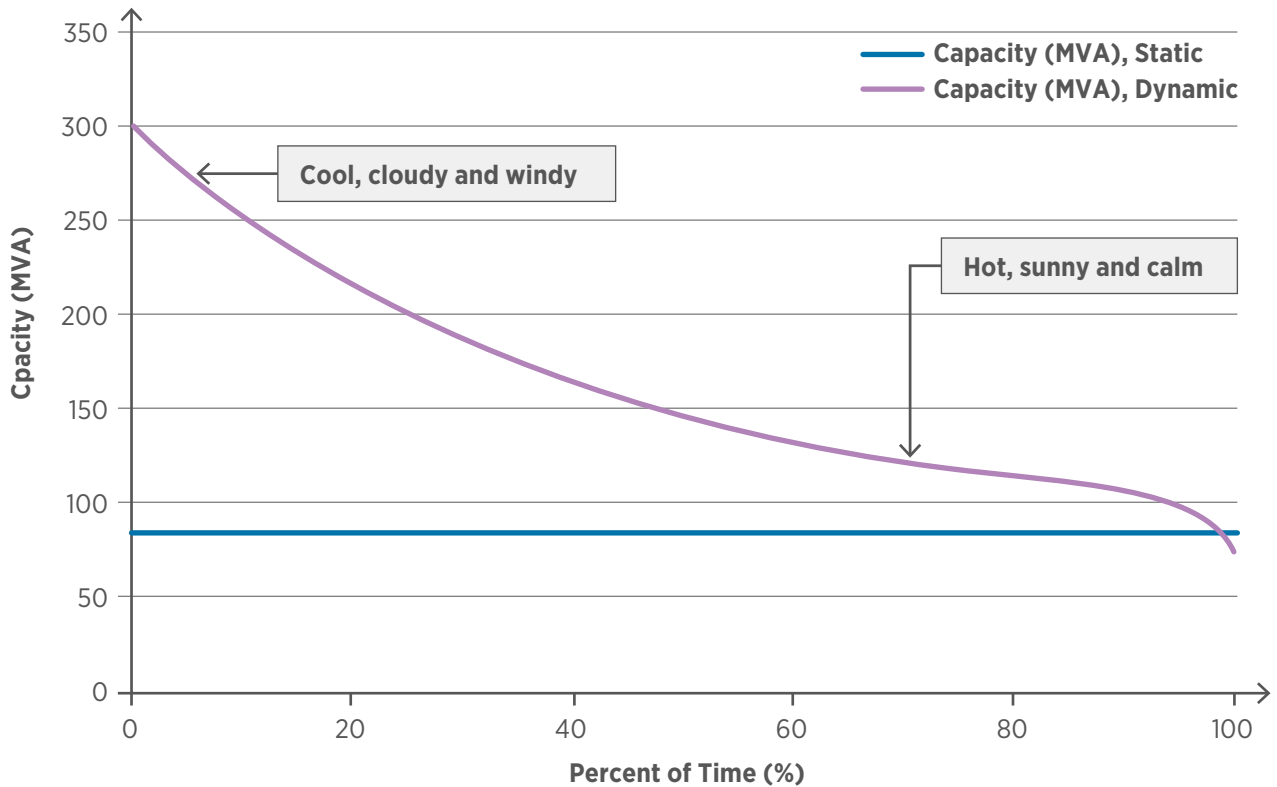

Note: MVA = megavolt ampere.
 Source: Based on ENTSO-E (2015).

Many grid operators are now considering using DLR systems as a practical means of increasing their transmission capacity. Belgium’s transmission system operator (TSO), Elia, has been working since 2008 to test and develop DLR systems that can provide forecast estimates of the ampacity over different time horizons (from a five-minute basis to the following two days) (Elia, 2020).

In most cases, relatively modest levels of rating increase (5% to 20%) over static ratings are sufficient to resolve system operational challenges. Therefore, DLR offers system operators a rapidly deployable, low-cost method of increasing line ratings, which can be implemented without the need to build new physical infrastructure or put key lines out of service.

II. CONTRIBUTION TO POWER SECTOR TRANSFORMATION

DLR offers many applications and benefits to the power system. It reduces congestion in the power system, optimises asset utilisation in a safe manner, results in additional income from existing power generation assets, improves cost efficiency of the lines and avoids investment in new lines. All these can ultimately result in lower prices for consumers, faster integration of distributed energy resources and greater power system integration of VRE.

DLR can contribute to overall system planning, because it can forecast the power-carrying capacity. Using DLR can also enhance grid resilience, key to maintaining security of supply.

In the case of substations or power lines being lost to natural or man-made calamities, a resilient grid provides alternative transmission paths around the damaged portion of the grid. With reliable hour(s)-ahead to day(s)-ahead forecasting, DLR can provide “emergency” rating for all remaining in-service lines (McCall and Servatios, 2016).

Whilst DLR has numerous important benefits to the power sector, the following section focuses on those benefits with a direct impact on VRE integration (Figure 3).

Figure 3 Key contributions of DLR to VRE integration

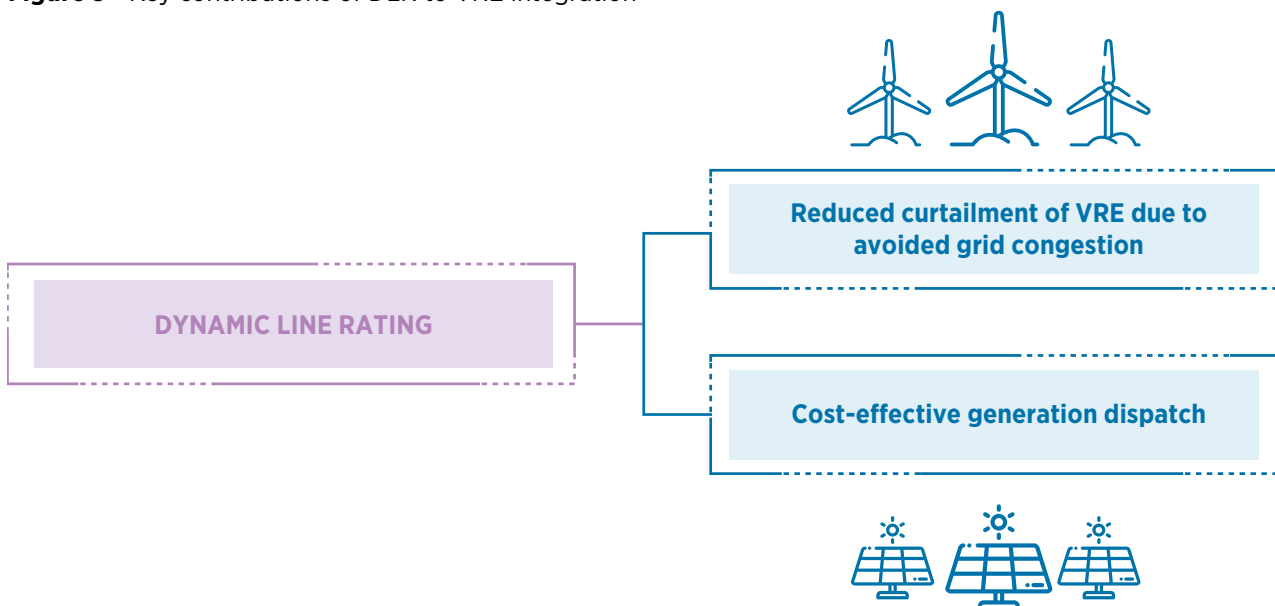

Reduced curtailment of VRE due to avoided grid congestion

DLR facilitates integration of a higher share of renewable generation by increasing the effective transmission or distribution network capacity. This in turn reduces the need for investment in transmission network reinforcements, at least in the short to medium term.

There are particularly great synergies between DLR and wind energy. In wind resource-rich areas, the wind enables turbines to produce power while it cools nearby transmission lines. Therefore, the transmission capacity of the lines increases with wind speed, because of the increased cooling. So, a correlation between wind power generation and the transmission capacity of close lines exists (dynamic limit). Thus, when planning wind power integration, considering the dynamic line limit rather than the static limit increases estimated capacity (Fernandez *et al.*, 2016). This favourable correlation has been made use of in several pilot projects. One example is Belgium, where DLR is implemented on the lines that connect the offshore wind farms in the North Sea to the mainland (Ampacimon, 2019).

Cost-effective generation dispatch

DLR deployment can increase transmission and distribution capacity, which in turn can increase the amount of power available for dispatch. This increased power supply can then contribute to reducing generation dispatch costs. Furthermore, the implementation of DLR can also enhance intraday operations, as short-term decisions are also based on real-time thermal rating information.

It also enables the reduction of congestion costs, due to more accurate forecasts by traders and generator commitments in day-ahead markets, as well as a more efficient real-time market with a better estimation of expected transmission capacity. In addition, the transmission capacity gain can be used for power trades on the market, especially in the case of interconnected market areas. This results in additional income from existing generation assets.



Potential impact on power sector transformation

- DLR implemented by Elia, the TSO in Belgium, resulted in a **30% increase in a line's current** (Elia, 2019). The same result was achieved by RTE, the French TSO, when implementing DLR (RTE, 2017).
- The TWENTIES project, under the EU FP7 research and technology programme, involved various stakeholders, including European TSOs, generators, and power technology and wind equipment manufacturers. It concluded that DLR forecasts lead to an average **increase in transmission capacity of 10–15%** (Pavlinić and Komen, 2017).
- Grid congestion costs reached EUR 1 billion in 2017 and 2018 in Germany. The cost of congestion is about EUR 4 million (USD 4.8 million) per day, while the average dispatch cost is EUR 23 000 per gigawatt hour (GWh). For example, Line Ville Ost, which links Rommerskirchen and Sechtem, had 393 hours of redispatch, resulting in a 273 GWh reduction at one end and a 271 GWh increase at the other, totalling 431 GWh redispatched. Applying DLR on this line would result in a **25% capacity increase on the line 50% of the time**, and a **15% gain 90% of the time**.
- On a typical day, this would save 6 hours' redispatch of 200 MW, meaning 1 200 MWh avoided redispatch. This would **save EUR 27 000 per day** (Ampacimon, 2019).
- AltaLink conducted an analysis for a wind plant installation in Canada and found concurrent cooling avoided the need for system upgrades. The analysis showed an **average 22% capacity increase** over static ratings 76% of the time (Bhattari *et al.*, 2018).
- According to simulation studies carried out by Estanqueiro *et al.* (2018), DLR deployment **can reduce curtailment** due to ampacity issues and **increase mean ampacity by 20–40%**. In windy conditions, the ampacity was seen to increase by as much as ~150% of the nominal ampacity.
- Small changes in weather conditions can have a considerable impact on the ampacity of a transmission line. Assuming a 20-mile long aluminium conductor steel reinforced transmission line with a static line rating of 787 amperes at 40 °C, zero wind and a midday in summer, changes in the ampacity can be seen under various weather conditions (Table 1) (Aivaliotis, 2014).

Table 1 Key facts about the emerging role of distribution system operators

	Change in ampacity	New ampacity
Ambient temperature		
2 °C fluctuation	+/- 2% capacity	
10 °C drop in ambient	+11% capacity	874 amperes
Solar radiation		
Clouds shadowing	+/- a few percent	
Middle of night	+18% capacity	929 amperes
Wind increase of 1 m/s		
45° angle	+35% capacity	1 060 amperes
95° angle	+44% capacity	1 130 amperes

Note: m/s = metre per second.

Source: Aivaliotis (2014).

III. KEY FACTORS TO ENABLE DEPLOYMENT

Defining algorithms for ampacity calculations

Different algorithms exist for the calculation of the ampacity of the particular span or tensioning section. Most existing algorithms, however, introduce uncertainties. These may be substantial, especially when the loading of the line is approaching the maximum conductor temperature, for example 80 °C. Moreover, algorithms should be tailored to the specific conditions and implementation philosophy of grid operators. Improvements in ampacity calculation algorithms are critical for the large-scale adoption of DLR (ENTSO-E, 2015).

Figure 4 shows the complexity in assessing the DLR. Besides formulating a good algorithm for ampacity calculation, a large amount of data is needed as input, such as:

- Physical properties of the conductor.
- Geographical information for all spans.
- Atmospheric conditions for all spans.

This is so the operator can be aware of hotspots like spans with low clearance or reduced conductor cross-section.

Digitalisation for real-time monitoring and communication systems

Given the large number of factors that can influence the ampacity of a line and the need for real-time data, digitalisation has an important role in enabling the use of DLR and enhancing its benefits. Line monitoring equipment must be in place and connected to systems that can communicate in real time with system operators, to support them in decision making.

This means that the backbone monitoring and communications infrastructure has to be robust and up-to-date. Smart devices connected to the internet, like sensors along the transmission and distribution lines, coupled with digital technologies like artificial intelligence and big data, enable the use of DLR (for more information see the *Innovation landscape briefs: Internet of things* [IRENA, 2019b] and *Artificial Intelligence and Big Data* [IRENA, 2019c]).

A project by Oncor Electric Delivery Company employed a fully automated DLR system capable of collecting various transmission line parameters at remote locations on the transmission line. The DLR system then passed the data to the system operator and Oncor for transmission capacity allocation and decision making. However, the system's data communication proved not fast enough to satisfy the decision-making algorithm's needs (US DOE, 2014), which highlights the importance of monitoring, communication and control systems.

To harness the benefits of DLR, transmission and distribution line monitoring systems and equipment need to be well integrated into the networks. Line monitoring systems can be deployed on the lines, or in proximity to the lines, to capture real-time weather conditions (Ntuli, *et al.*, 2016). This equipment must capture data such as actual line conditions, critical weather parameters, circuit loads and transmission line temperature. Outputs can then be used when making operational decisions for thermal load management on the lines. Field data, applied to industry standards such as IEEE 738 and Cigre TB498, provide "real-time" ampacity ratings. These ratings can be enhanced into forecasts with algorithms, including mathematical methods combining statistics, modelling and weather forecasts, to support the operation of the grid.

Regulations to encourage optimised operational solutions

Traditionally, investment cost-based regulation approaches (“rate of return regulation” or “cost-plus regulation”) were widely used in liberalised power sectors for grid operation and investment decisions. The rate of return model provides a regulated transmission company with a certain pre-defined “rate of return” on its regulatory asset base.

Cost-plus regulation is another approach, in which a predefined profit margin is added to the investment costs of the grid operator. These regulations based on capital expenditure (CAPEX) provide limited incentive for TSOs to minimise their investment in new physical infrastructure and create a favourable environment for CAPEX over operational expenditure (OPEX) solutions.

This CAPEX incentive has been increasingly investigated by regulators, and in response they have developed OPEX-based regulations to give grid operators the incentive to improve operational practices by increasing the efficient use of existing infrastructure. Rewards and penalties incentivise system operators to achieve the goals by allowing them to share the “extra profit” if they exceed the transmission capacity targets set by the regulator. Incentives for OPEX-related solutions can lead to innovative ways of operating the power system, such as DLR, which can help reduce or avoid CAPEX investment in new physical infrastructure, whenever possible.

In vertically integrated power systems, the incentive of the power system operator to make use of DLR is driven by the fact that it can dispatch the power generated by its own VRE assets more cost-effectively, thereby reducing the need for CAPEX for new lines and increasing the rate of return on their power generating portfolio.

Figure 4 The variability of influencing factors on DLR

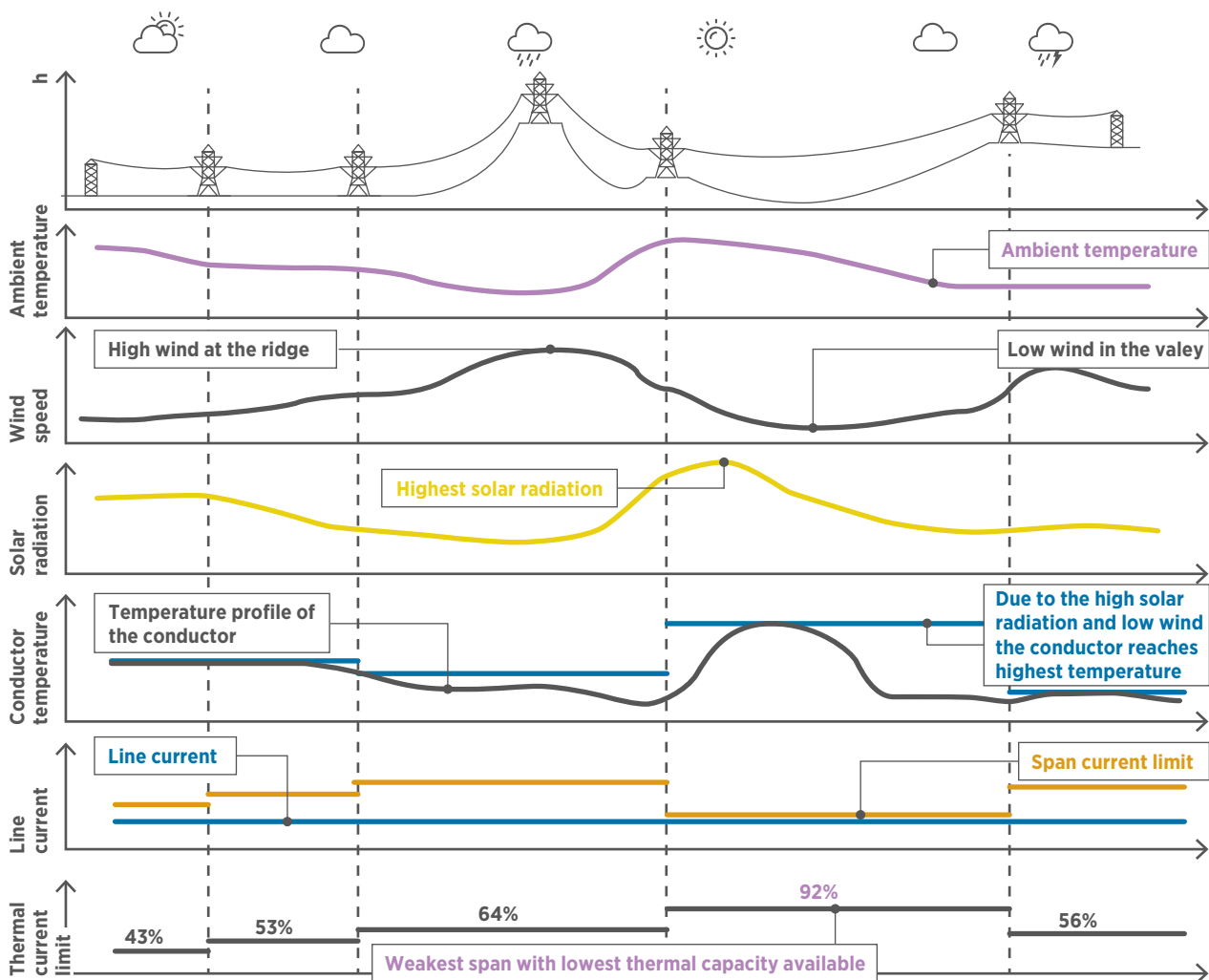

Note: Thermal current limit is the maximum current permitted to ensure no conductor material is damage and no maximum line sag is exceeded.

Source: ENTSO-E (2015).

IV. CURRENT CONTEXT AND ONGOING INITIATIVES

Since the implementation of flow-based market coupling in 2015 in the former capacity calculation region of Central-West Europe, some TSOs include DLR in the calculation of cross-border transmission capacity. This can increase the tradable volume of electricity among countries in the European market. For example, in 2017–2018 the thermal limits were increased by 20% in cold weather conditions when electricity demand was high. In 2018 Amprion installed 28 new weather stations in addition to the 14 existing ones. These are located along the most heavily loaded lines at meteorologically exposed locations (i.e. pylons and substations), and it estimates that capacity values can be increased by up to 37% under appropriate weather conditions (Amprion, 2019).

Moreover, within the flow-based market coupling methodology, following its Decision No. 02/2019, the Agency for the Cooperation of Energy Regulators (ACER) reinforced the obligation in the so-called “Core” capacity calculation region (concerning TSOs from 13 countries) to gradually replace seasonal limits with a dynamic limit for each hour of transmission capacity made available for trading on the pan-European intraday market.

Table 2 lists a range of DLR initiatives and projects implemented in various countries.



Table 2 Example of countries implementing DLR

Country	Case study
Belgium	Belgium's TSO, Elia, uses DLR on several overhead lines to increase its import capacity. Belgium has faced interconnection issues due to increased need for imports following the shutdown of nuclear plants with a capacity of 3 000 MW in 2014. Belgium imports electricity from neighbouring countries through interconnectors, but the maximum import capacity – based on traditional seasonal rating of the transmission lines crossing the Belgian border – would be insufficient to supply winter peak demand. Elia implemented DLR, resulting in thermal ratings (due to wind cooling) of more than 200% of the seasonal rating on power lines. However, other transmission system assets (for example, transformers and circuit breakers) have lower ratings. The rule applied for Belgian lines limits the gain generated by the dynamic rating to 130% of the seasonal rating (Bourgeois, 2017).
Bulgaria and Slovenia	The Flexitranstore project, under EU Horizon 2020, is conducting a demonstration project on two sites, one in the electricity grid of Electro Ljubljana, Slovenia, and the second in northeastern Bulgaria on the 220 kilowatt power line Karnobat-Varna. The project aims to demonstrate sensor technology that allows power system operators to effectively handle and prevent sudden and often fatal failures, especially during icy weather conditions, increasing system security and reliability by reducing icing phenomena and facilitating cross-border power exchanges (Flexitranstore, 2017).
France	French TSO, RTE, started experimenting with DLR technologies in 2009 and conducted pilot projects including “Ampacité” and “Ampacité 2” between 2012 and 2018. The main rationale for RTE is to optimise the integration of wind farms, most of which are connected to the sub-transmission grid under 63 kilovolts (kV) and 90 kV (RTE, 2017).
Italy	Italian TSO, Terna, is conducting pilot applications of DLR systems on four of its transmission lines, namely Spezia-Vignole (380 kV), Bargi-Calenzano (380 kV), Misterbianco-Melilli (220 kV) and Benevento-Foiano (150 kV). The project involves the deployment of DLR equipment on the transmission line itself and at two end-point substations. It also utilises the weather forecast data taken from the Epson Meteo Center to estimate the DLR value. This has allowed greater capacity on transmission lines during favourable weather conditions, enabling the increased integration of wind energy generation from nearby wind farms (Carlini, Massaro and Quaciari, 2013).
Texas (U.S.)	Oncor Electric Delivery Company, a transmission and distribution system operator in Texas, implemented a DLR system in a project funded under the US Department of Energy's Smart Grid Demonstration Program. On average, line congestion costs the Oncor transmission system in Texas about USD 250 000 per line per day (Clean Energy Grid, 2014). The DLR system monitored the real-time capacity of eight transmission lines that were being used for daily operations and wholesale market transactions. The project covered five 345 kV and three 138 kV transmission lines; it had an installed cost of USD 4.833 million. The real-time capacity of the 138 kV lines increased by 8–12% on average, while the 345 kV line experienced 6–14% increase in real-time capacity on average. As a second project, Oncor deployed DLR on five lines in West Texas for congestion relief (US DOE, 2014; Engerati, 2014).
Uruguay	In 2018 renewable energy sources accounted for 97% of the power generated in Uruguay, with wind power accounting for 22% in the same year. Uruguay's utility could increase its share of wind power in the total generation mix thanks to a combination of innovations, including the application of DLR on its transmission lines. Given that the renewable power generating assets are distributed throughout the country, but the capital, Montevideo, which is the key demand centre, lies at the south of the country, transporting power through the country was a key challenge. Increasing the transmission line rating dynamically at sub-hour level, in addition to hourly forecasts, helped reduce the curtailment of wind power. ²
Viet Nam	In the smart grid roadmap for Vietnam, DLR was identified as a tool to improve operational efficiency and to alleviate concerns on lines that are experiencing rapid load growth (World Bank, 2016)

² Information presented by UTE, Uruguay's government-owned power company, during the IRENA “Workshop on innovative solutions for achieving 100% renewable power systems by mid-century” in Montevideo, Uruguay, in July 2019 (www.irena.org/events/2019/Jul/Workshop-on-Innovative-solutions-for-achieving-100pc-renewable-power-systems-by-mid-century).

V. IMPLEMENTATION REQUIREMENTS: CHECKLIST

TECHNICAL REQUIREMENTS



Implementation of the following steps:

- line identification;
- sensor installation;
- data communication;
- data analytics;
- computing and temperature forecasting;
- validation (for improved visualisation).

Hardware:

- DLR equipment such as line monitors that are self-contained (encompassing auxiliary power, communications and all measurement sensors), sag detectors, weather stations, data loggers and communication devices.

Software:

- Tailored algorithm for transmission capacity calculation for each line.
- Data logging software to record and analyse data from DLR equipment.
- Data analysis software deployed by system operators to analyse data generated by DLR systems. These software must be interoperable with existing software used by system operators.
- Forecasting algorithms, complemented by artificial intelligence tools, to improve DLR performance, minimising weather forecast and operational errors.

Communication protocols:

- 4G/5G-enabled DLR equipment that can be used for real-time relay of data to system operators.

REGULATORY REQUIREMENTS



- In liberalised electricity markets, regulation incentivising OPEX-based solutions and enabling innovations in grid operations, including digital technologies.
- Mandated or incentivised measurement of transmission capacity limits on the power system based on real-time thermal ratings of transmission and distribution lines.

STAKEHOLDER ROLES AND RESPONSIBILITIES



Increased collaboration between various data providers:

- Improved communication channels for collaboration between meteorology data providers, VRE asset owners, power supply utilities or generators, and the transmission and distribution system operators to improve understanding of power supply and demand flows, which help tailor the actions required to limit and reduce congestion.

Transmission and distribution system operators:

- Studying the most congested lines on the system and assessing the cost-effectiveness of implementing DLR, e.g. by comparing the cost-benefit analyses of DLR with investment in new transmission lines. Transmission lines that are not congested, or do not limit market activity (where applicable), may not benefit fully from DLR. Similarly, power systems that are constrained by voltage, stability or substation limitations may not benefit from DLR. However, DLR may increase significantly welfare benefits by increasing the volume of traded electricity across borders, where investment in new transmission lines would be very costly.
- Integrating DLR in system operation tools and procedures: DLR data streams need to be integrated into the processes that underlie the markets, such as the calculation of tradable transmission capacity for intraday and day-ahead markets, where such arrangements are in place.
- Providing technical training for staff for deployment of DLR technologies.
- Conducting pilot projects aimed at increasing the understanding of the costs and benefits of this technology.

ABBREVIATIONS

ACER	Agency for the Cooperation of Energy Regulators	MW	Megawatt
CAPEX	Capital expenditure	MWh	Megawatt hour
DLR	Dynamic line rating	m/s	Metre per second
GWh	Gigawatt hour	OPEX	Operational expenditure
IRENA	International Renewable Energy Agency	TSO	Transmission system operator
kV	Kilovolt	VRE	Variable renewable energy
MVA	Megavolt ampere	4G	Fourth generation
		5G	Fifth generation

BIBLIOGRAPHY

- ACER** Decision No 02/2019.
- Ampacimon** (2019), “Smart grid world of innovations: Dynamic line rating webinar”, ENTSO-E, www.youtube.com/watch?v=C6LP363zSmo.
- Amprion** (2019), “Amprion Market Report 2019”, www.amprion.net/Dokumente/Dialog/Downloads/Stellungnahmen/Amprion-Market-Report-2019.pdf.
- Aivaliotis**, S. K. (2014), “Dynamic line ratings for optimal and reliable power flow”, www.ferc.gov/CalendarFiles/20100623162026-Aivaliotis,%20The%20Valley%20Group%206-24-10.pdf.
- Bhattari**, B. *et al* (2018), “Improvement of transmission line ampacity utilization by weather-based dynamic line rating”, *IEEE Transactions on Power Delivery*, Vol. 33, No. 4, pp. 1 853–1 863.
- Bourgeois**, R. and Lambin, J. (2017), “Dynamic Ratings Increase Efficiency,” March 8, 2017, https://watttransmission.files.wordpress.com/2018/01/ampacimon-dynamic-ratings-increaseefficiency_belgium-transmission-grid.pdf.
- Carlini**, E. M., F. Massaro and C. Quaciari (2013), “Methodologies to uprate an overhead line: Italian TSO case study”, *Journal of Electrical Systems*, Vol. 9–4, pp. 422–439.
- Clean Energy Grid** (2014), “Dynamic line ratings”, <https://cleanenergygrid.org/wp-content/uploads/2014/08/Dynamic-Line-Ratings.pdf>.
- Elia** (2019), “Smart grid world of innovations: dynamic line rating”, ENTSO-E, www.youtube.com/watch?v=C6LP363zSmo.
- Elia** (2020), “Dynamic line rating”, www.elia.be/en/infrastructure-and-projects/our-infrastructure/dynamic-line-rating.
- Engerati** (2014), “Oncor demonstrates dynamic line rating”, www.engerati.com/transmission-distribution/oncor-demonstrates-dynamic-line-rating-system/.
- ENTSO-E** (2019), “Smart grid world of innovations: Dynamic line rating”, European Network of Transmission System Operators for Electricity, www.youtube.com/watch?v=C6LP363zSmo.

ENTSO-E (2015), “Dynamic line rating for overhead lines”, European Network of Transmission System Operators for Electricity, https://docstore.entsoe.eu/Documents/SOC%20documents/Regional_Groups_Continental_Europe/Dynamic_Line_Rating_V6.pdf.

Estanqueiro, A. I. *et al.* (2018), “DLR use for optimization of network design with very large wind (and VRE) penetration”, Stockholm, 17th Wind Integration Workshop.

Fernandez, E. *et al.* (2016), “Review of dynamic line rating systems for wind power integration”, Renewable and Sustainable Energy Reviews, Vol. 53, pp. 80–92.

Flexitranstore (2019), “Demonstration 3: Dynamic line rating technology”, www.flexitranstore.eu/Demo-3.

Goodwin, T., Aivaliotis, S., Mohr, R., Stelmak, R. (2014), “Integrating enhanced dynamic line rating into the real-time state estimator”, https://cigreindia.org/CIGRE%20Lib/CIGRE-Paris-Session-2014-papers-Report/B2/B2_208_2014.pdf.

IRENA (2019a), “Innovation landscape for a renewable-powered future: Solutions to integrate variable renewables”, International Renewable Energy Agency, Abu Dhabi.

IRENA (2019b), “Innovation landscape briefs: Internet of things”, International Renewable Energy Agency, Abu Dhabi.

IRENA (2019c), “Artificial intelligence and big data”, International Renewable Energy Agency, Abu Dhabi.

McCall, J. C. and B. Servatios, (2016), “Enhanced economic and operational advantages of next generation dynamic line rating systems”, CIGRE.

Ntuli, M. *et al.* (2016), “Increasing the capacity of transmission lines via current uprating: An updated review of benefits, considerations and developments”, 2016 Australasian Universities Power Engineering Conference (AUPEC), Brisbane.

Pavlinić, A. and V. Komen (2017), “Direct monitoring methods of overhead line conductor temperature”, Engineering Review, Vol. 37, Issue 2, pp. 134–146.

RTE (2017), “Sensors on power lines to measure the wind and integrate more renewable energy in Haute-Marne” (press release), www.rte-france.com/sites/default/files/20170627_cp_rte_capteurs.pdf.

US DOE (2014), “Oncor’s pioneering transmission dynamic line rating (DLR) demonstration lays foundation for follow-on deployments”, US Department of Energy, www.smartgrid.gov/files/Oncor_DLR_Case_Study_05-20-14_FINAL.pdf.

World Bank (2016), “Smart grid to enhance power transmission in Vietnam (English)”, World Bank Group, Washington, DC.

Zeiselmaier, A. and F. Samweber (2016), “Overhead line monitoring”, www.ffe.de/publikationen/veroeffentlichungen/639-freileitungsmonitoring.

DYNAMIC LINE RATING

INNOVATION LANDSCAPE BRIEF

© IRENA 2020

IRENA HEADQUARTERS

P.O. Box 236, Abu Dhabi
United Arab Emirates

www.irena.org

